

F012 654 100

Issue } 00-11-07
Stand }

Fig./Abb. 1

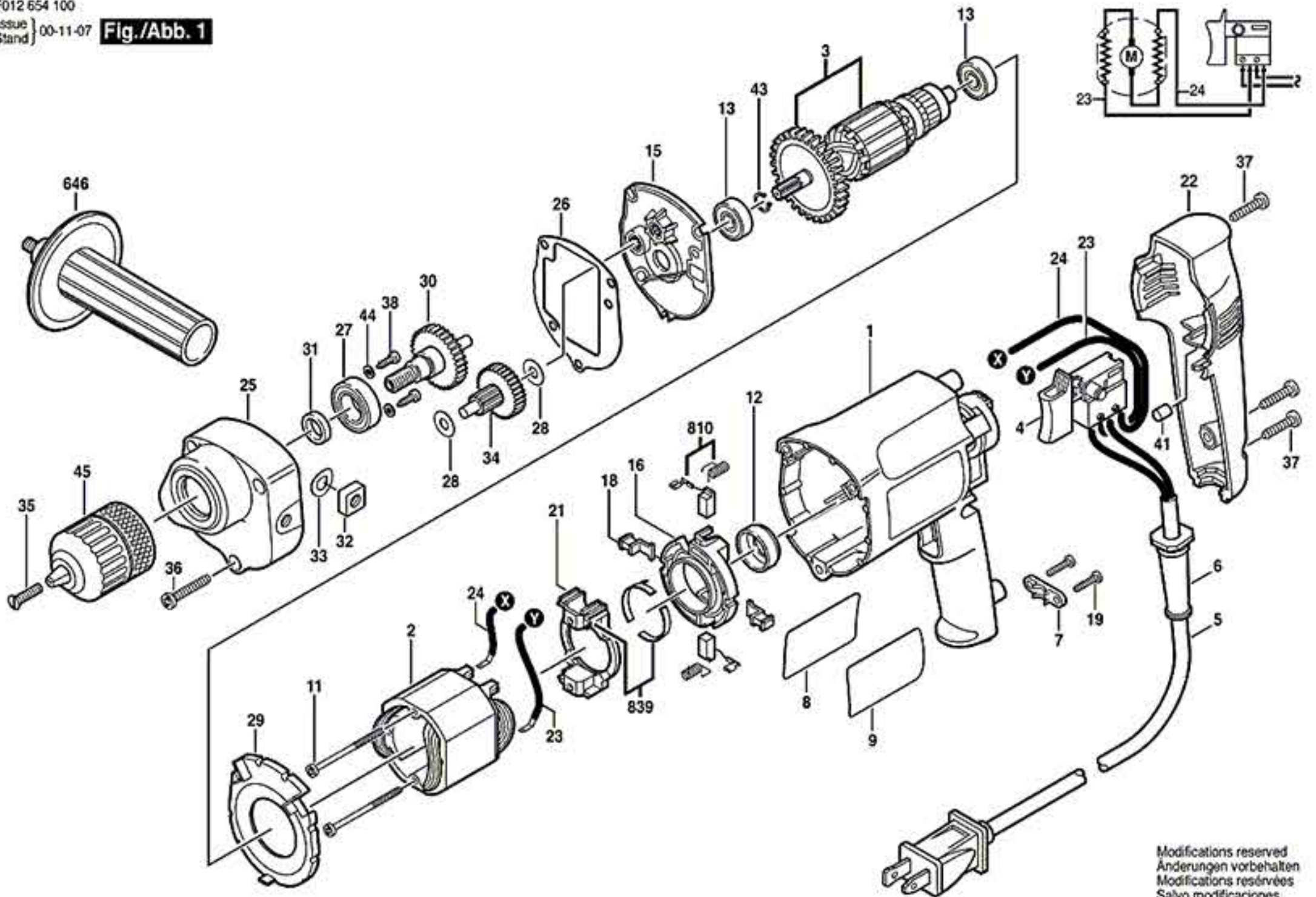

Modifications reserved
Änderungen vorbehalten
Modifications réservées
Salvo modificaciones