

F012264504

Stand }
Issue } 00-11-08

Fig./Abb. 1

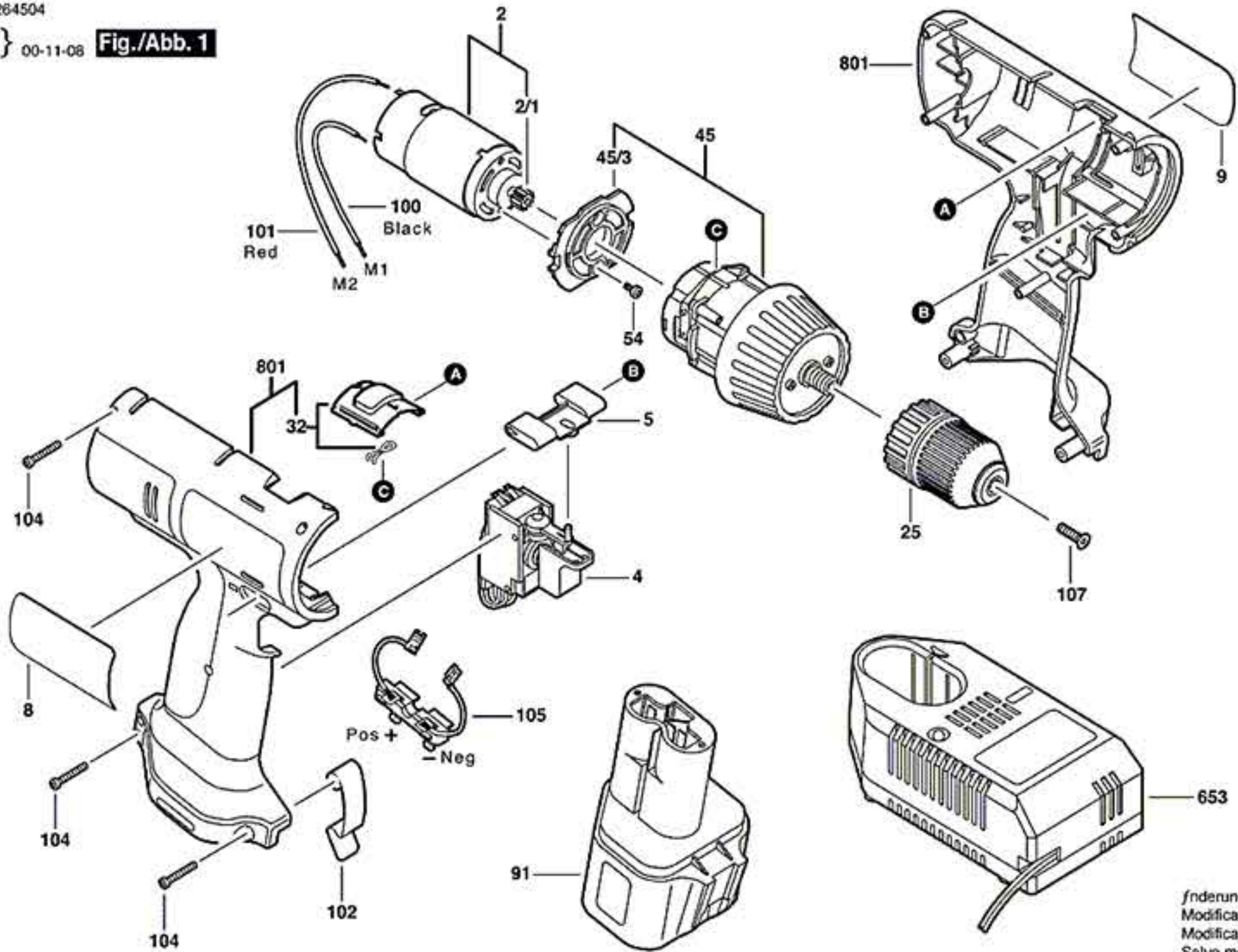

Änderungen vorbehalten
Modifications reserved
Modifications reserves
Salvo modificaciones