

0 603 310 735

Stand 08-02
Issue 07-11-09

Fig./Abb. 1

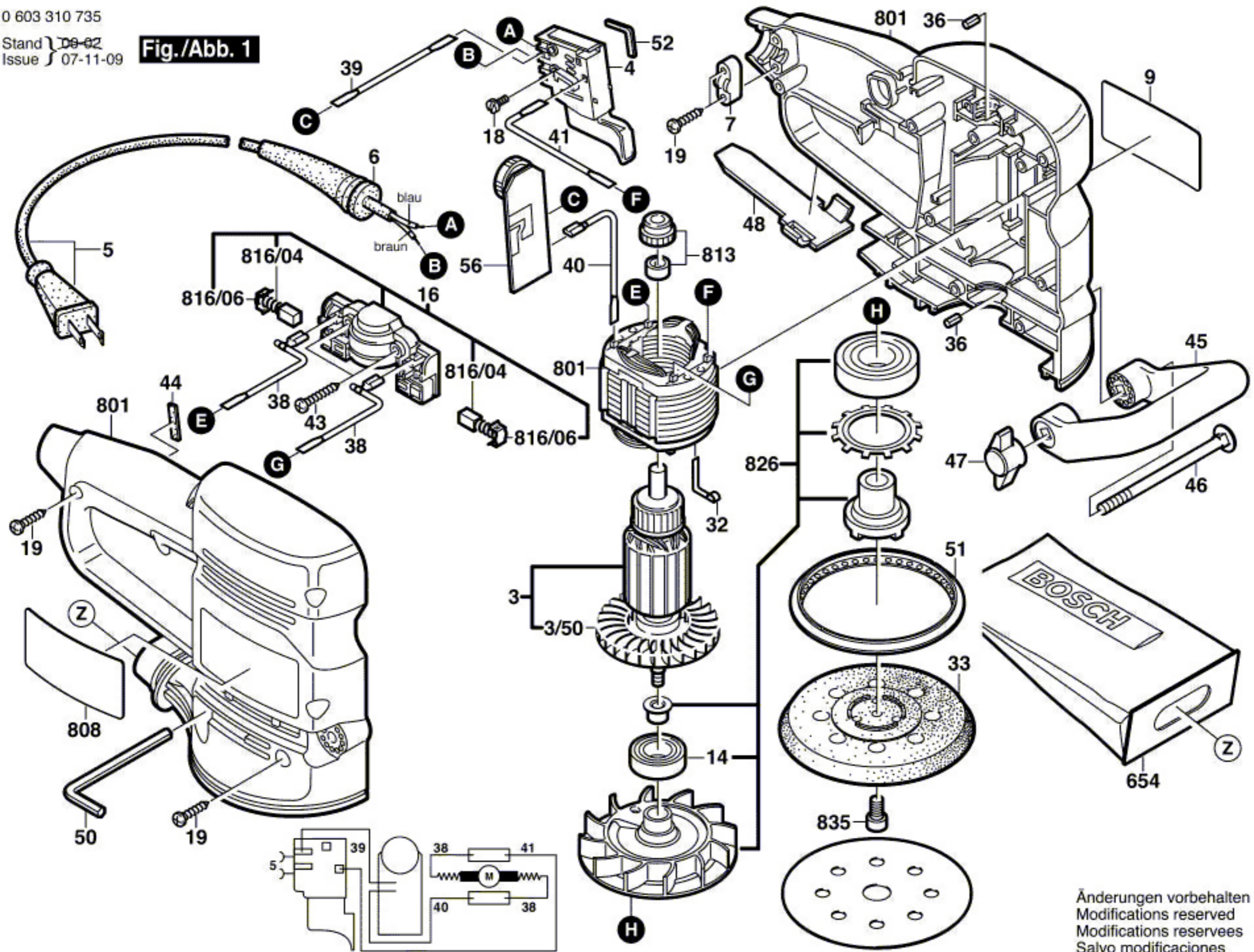

Änderungen vorbehalten
Modifications reserved
Modificaciones reservées
Salvo modificaciones