







Model IW50HAP-4F/IW50HAP-4P

1/2" Twin Hammer Pistol Grip Impact Wrenches

Form # ZCE719
Date 4-03/A



Operator Instructions Includes – Foreseen Use, Work Stations, Putting Into Service, Operating, Dismantling, Assembly and Safety Rules.		Important Read these instructions carefully before installing, operating, servicing or repairing this tool. Keep these instructions in a safe accessible place.	
Manufacturer/Supplier Sioux Tools, Inc. 250 Snap-on Drive P.O. Box 1596 Murphy, NC 28906 U.S.A. Tel No. 828-835-9765 Fax No. 828-835-9685		Product Type 1/2" Twin Hammer Pistol Grip Impact Wrenches	Max. RPM 8,000 Cycles Per Min. 
		Model No/Nos IW50HAP-4F (Ring) IW50HAP-4P (Pin)	Serial No.
Product Net Weight 5.0 lbs 2.3 Kg	Recommended Use Of Balancer Or Support NO	Recommended Hose Bore Size – Minimum 3/8 ins 10 mm	Recommended Max. Hose Length 30 Ft 10 M
Air Pressure Recommended Working Maximum 6.2 bar 90 PSI 6.2 bar 90 PSI		Noise Level: Sound Pressure Level 97.2 dB(A) Sound Power Level 110.2 dB(A) Test Method: Tested in accordance with Pneurop test code PN8NTC1 and ISO Standard 3744	
SAFETY MESSAGES Personal Safety Equipment Use – Safety Glasses YES Use – Safety Gloves Use – Safety Boots Use – Breathing Masks Use – Ear Protectors YES	WARNING  Always Read Instructions Before Using Power Tools  Always Wear Safety Goggles  Wear Hearing Protection  Avoid Prolonged Exposure To Vibration	Vibration Level 3.17 Meters / Sec² Test Method: Tested in accordance with ISO standards 8662 Parts 1 & 7	

Safety rules when using IW50HAP-4F/IW50HAP-4P Impact Wrenches

- Use only impact sockets and extensions, universal joints, etc. rated as being suitable for use with impact wrenches.
- Prolonged exposure to vibration may cause injury.
- Read all instructions before using this tool. All operators must be fully trained in its use and aware of these safety rules.
- Do not exceed the maximum working air pressure.
- Use personal protection equipment as recommended.
- Some dust created by power sanding, sawing, grinding, drilling, and other construction activities contains chemicals known to cause cancer, birth defects and other reproductive harm.
- Use only compressed air at the recommended conditions.
- If the tool appears to malfunction, remove from use immediately and arrange for service and repair. If it is not practical to remove tool from service, then shut off the air supply to the tool and write or have written a warning note and attach it to the tool.
- If tool is to be used with a balancer or other suspension device, ensure that the tool is firmly attached to the suspension/support device.
- When operating the tool, always keep

- the body and particularly the hands away from the working attachment fixed to the tool.
- The tool is not electrically insulated. Never use the tool if there is any chance of coming into contact with live electricity.
- Always when using the tool, adopt a firm footing and/or position and grip the tool sufficiently only to overcome any reaction forces that may result from the tool doing work. Do not overgrip.
- Use only correct spare parts for maintenance and repair. Do not improvise or make temporary repairs. Major servicing and repairs should only be carried out by persons trained to do so.
- Do not lock, tape, wire, etc. the 'On/Off' valve in 'On' position. The trigger/lever, etc. must always be free to

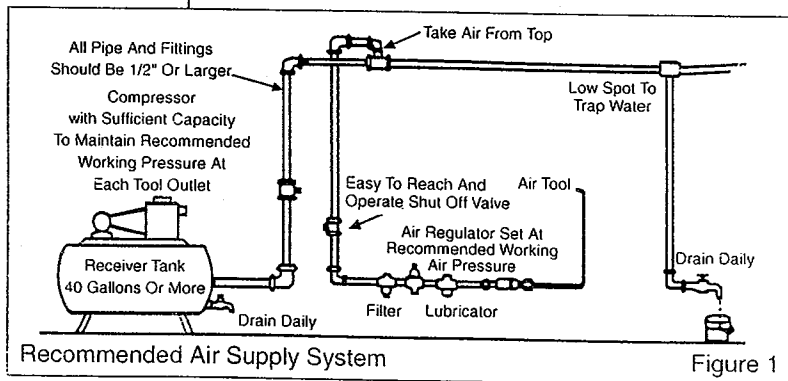

return to the 'Off' position when released.

- Always shut off the air supply to the tool and press the 'On/Off' valve to exhaust the air from the feed hose before fitting, removing or adjusting the working attachment fitted to the tool.
- Before using the tool, make sure that a shut off device has been fitted to the air supply line and the position is known and easily accessible so that the air supply to the tool can be shut off in an emergency.
- Check hose and fittings regularly for wear.
- Take care against entanglement of the moving parts of the tool with clothing, hair, ties, cleaning rags, rings, jewelry, watches, bracelets, etc. This could cause the body or parts of the body to be drawn towards and in contact with the moving parts of the tool and could be very dangerous.
- It is expected that users will adopt safe working practices and observe all local, regional and country legal requirements when installing, using or maintaining the tool.
- Take care that the exhaust air does not point towards any other person or material or substance that could be contaminated by oil droplets. When first lubricating a tool or if the tool exhaust has a high oil content, do not allow the exhaust air to come near very hot surfaces or flames.
- Never lay the tool down until the working attachment has stopped moving.
- When the tool is not in use, shut off the air supply and press the trigger/lever to drain the supply line. If the tool is not to be used for a period of time, first lubricate, disconnect from air supply and store in a dry average room temperature environment.
- If the tool is passed from one user to a new or inexperienced user, make sure these instructions are passed with the tool.
- Do not remove any manufacturer fitted safety devices where fitted, i.e., wheel guards, safety trigger, speed governors, etc.
- Wherever possible, secure workpiece with clamps, a vise, etc. to make it rigid so it does not move during the work operation. Keep good balance at all times. Do not stretch or overreach.
- Try to match the tool to the work operation. Do not use a tool that is too light or heavy for the work operation. If in doubt, seek advice.
- In general terms, this tool is not suitable for underwater use or use in explosive environments — seek advice from manufacturer.
- Try to make sure that the work area is clear to enable the work task to be performed safely. If practical and possible, try to clear unnecessary obstructions before starting work.
- Always use air hose and couplings with minimum working pressure ratings at least 1 1/2 times the maximum working pressure rating of the tool.

Foreseen Use Of The Tool – IW50HAP-4F / IW50HAP-4P

The impact wrench is designed for the tightening and loosening of threaded fasteners within the range as specified by the manufacturer. It should only be used in conjunction with suitable impact type 1/2" square female drive nut running sockets. Only use sockets which are of the impact type.

It is allowed to use suitable extension bars, universal joints and socket adaptors between the square output drive of the impact wrench and the square female drive of the socket.

Do not use the tool for any other purpose than that specified without consulting the manufacturer or the manufacturer's authorized supplier. To do so may be dangerous.

Never use an impact wrench as a hammer to dislodge or straighten cross threaded fasteners. Never attempt to modify the tool for other uses and never modify the tool for even its recommended use as a nutrunner.

Work Stations

The tool should only be used as a handheld, hand operated tool. It is always recommended that the tool is used when standing on the solid floor. It can be used in other positions, but before any such use, the operator must be in a secure position having a firm grip and footing and be aware that when loosening fasteners the tool can move quite quickly away from the fastener being undone. An allowance must always be made for this rearward movement so as to avoid the possibility of hand/arm/body entrapment.

Putting Into Service

Air Supply

Use a clean lubricated air supply that will give a measured air pressure at the tool of 90 p.s.i./6.2 bar when the tool is running with the trigger fully depressed and the air regulator in its maximum opening flow position. Use recommended hose size and length. It is recommended that the tool is connected to the air supply as shown in figure 1. Do not connect a quick connect coupling directly to the tool, but use a whip or leader hose of approximately 12 inches length. Do not connect the tool to the air line system without incorporating an easy to reach and operate air shut off valve. The air supply should be lubricated. It is strongly recommended that an air filter, regulator, lubricator (FRL) is used, as shown in Figure 1, as this will supply clean, lubricated air at the correct pressure to the tool. Details of such equipment can be obtained from your supplier. If such equipment is not used, then the tool should be lubricated by shutting off the air supply to the tool, depressurizing the line by pressing the throttle lever on the tool. Disconnect the air line and pour into the hose adaptor (6) a teaspoonful (5ml) of a suitable pneumatic motor lubricating oil preferably incorporating a rust inhibitor. Reconnect tool to air supply and run tool slowly for a few seconds to allow air to circulate the oil. If tool is used frequently, lubricate on daily basis and if tool starts to slow or lose power. When lubricating, also ensure that the air strainer in hose adaptor (6) is clean. It is recommended that joint tightness of the threaded fastener assembly be checked with suitable measuring equipment. It is recommended that the air pressure at the tool while the tool is running is 90 p.s.i./6.2 bar.

Operating

The output of the impact wrench in prime working condition is governed by mainly three factors:

- a) the input air pressure;
- b) the time the impact wrench is operated on the joint. Normal time for joints of average tension requirement 3 to 5 seconds;
- c) the setting of the air regulator for a given joint at a given pressure operated for a given time.

The air regulator on end cap unit (21) can be used to regulate the output of the impact wrench if no other means of control is available. It is strongly recommended that an external pressure regulator, ideally as part of a filter/regulator/lubricator (FRL), is used to control air inlet pressure so that the pressure can be set to help control the tension required to be applied to the threaded fastener joint. There is no consistent, reliable torque adjustment on an impact wrench of this type. However, the air regulator can be used to adjust torque to the approximate tightness of a known threaded joint. To set the tool to the desired torque, select a nut or screw of known tightness of the same size, thread pitch and thread condition as those on the job. Turn air regulator to low position, apply wrench to nut and gradually increase power (turn regulator to admit more air) until nut moves slightly in the direction it was originally set. The tool is now set to duplicate that tightness, note regulator setting for future use. When tightening nuts not requiring critical torque values, run nut up flush and then tighten an additional one-quarter to one-half turn (slight additional turning is necessary if gaskets are being clamped). For additional power needed on disassembly work, turn regulator to its fully open position. This impact wrench is rated a 1/2" bolt size. Rating must be downgraded for spring U bolts, tie bolts, long cap screws, double depth nuts, badly rusted conditions and spring fasteners as they absorb much of the impact power. When possible, clamp or wedge the bolt to prevent springback.



IW50HAP-4F 1/2" Impact Wrench with Ring Anvil
IW50HAP-4P 1/2" Impact Wrench with Pin Anvil

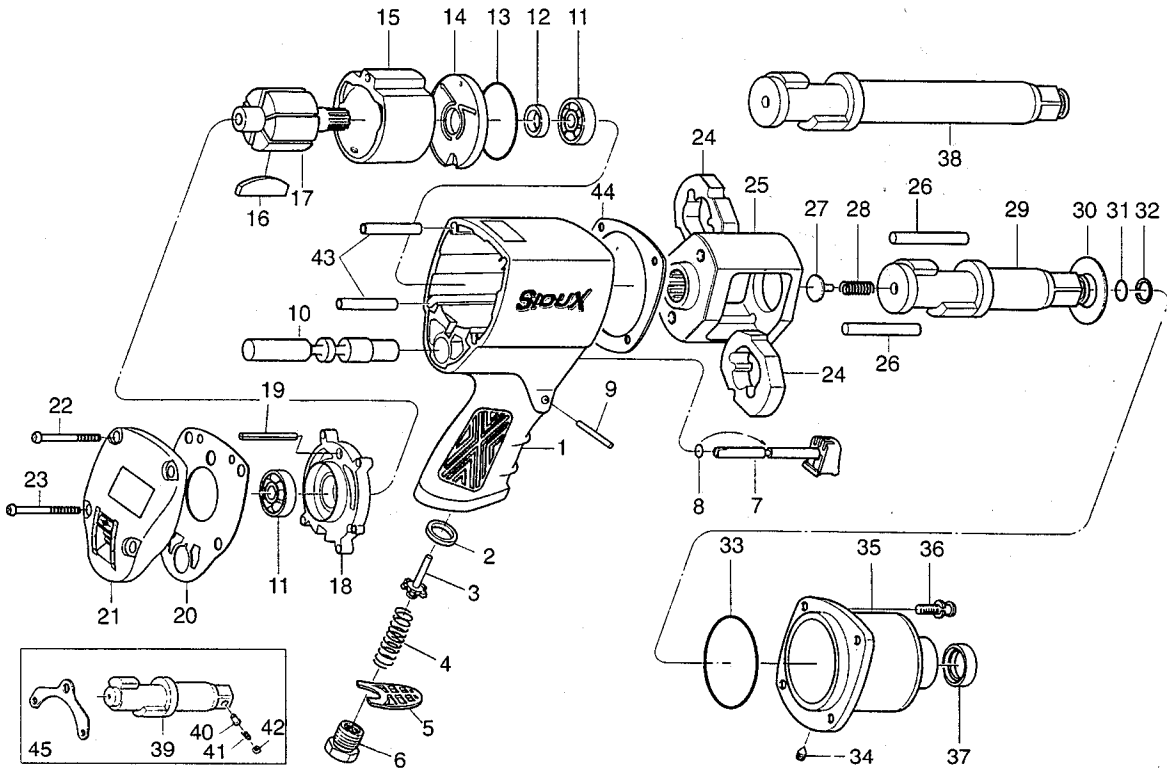

Ref.No.	Part No.	Description
1	506401	Motor Housing
2	68726	Valve Stem Bushing
3	506402	Valve Stem
4	506403	Throttle Spring
5	506404	Exhaust Deflector
6	66696	Hose Adaptor
7	506405	Throttle Trigger
8	506406	O-Ring
9	67229	Spring Pin
10	506408	Reverse Valve Unit
11	66658	Ball Bearing (2)
12	66664	Oil Seal
13	506409	O-Ring
14	506410	Front Plate
15	506411	Cylinder
16	506412	Rotor Blade (6)
17	506413	Rotor
18	506414	Rear Plate
19	68727	Guide Pin
20	506415	End Cap Gasket
21	506416	End Cap Unit
22	506417	Torx Screw (10-24UNCx70L) (2)
23	506418	Torx Screw (10-24UNCx80L) (2)
24	66669	Twin Hammer (2)

Ref.No.	Part No.	Description
25	505157	Hammer Cage
26	66670	Hammer Pin (2)
27	505161	Thrust Button
28	68731	Compression Fitting
29	506286	Ring Anvil
30	66672	Anvil Spacer
31	66673	O-Ring
32	66674	Socket Retaining Ring
33	68734	O-Ring
34	66604	Oil Plug
35	506420	Clutch Housing
36	68728	Torx Screw (10-24UNCx22L) (4)
37	66677	Oil Seal
38	506422	Long Ring Anvil
39	506285	Pin Anvil
40	505154	Lock Fitting
41	66729	Spring
42	505155	Lock Coller
43	68729	Support Rod (4)
44	68730	Front Gasket
45	66732	Hanger
Not Shown	68732	Nameplate (IW50HAP-4P)
Not Shown	68733	Nameplate (IW50HAP-4F)
Not Shown	505001	Warning Label

*Order Quantity as Needed

Soak rusted nuts in penetrating oil and break rust seal before removing with impact wrench. If nut does not start to move in three to five seconds use a larger size impact wrench. Do not use impact wrench beyond rated capacity as this will drastically reduce tool life. NOTE: Actual torque on a fastener is directly related to joint hardness, tool speed, condition of socket and the time the tool is allowed to impact.

Use the simplest possible tool-to-socket hook up. Every connection absorbs energy and reduces power.

Forward/reverse operation is controlled by reverse valve unit (10) located just above trigger (7). Depress reverse valve (10) until a distinct click is heard and the valve remains depressed. The tool is now in reverse mode. Fully depress valve again and the reverse valve unit (10) will release allowing forward operation. Ensure that the reverse valve unit is in the proper position before starting tool.

The air regulator controls the speed of the tool and is located on the lower portion of end cap (21). It is a 3-position, thumb operated regulator with "3" being the highest setting and "1" the lowest setting. Using thumb, move the slide downwards to increase speed and upwards to decrease speed.

The tool incorporates an air strainer in hose adaptor (6). Check periodically to see if this is becoming blocked as blockage will reduce the speed and power of the tool. To clean the air strainer it is necessary to remove the hose adaptor (6) from motor housing (1). For best results:

- 1) Always use the correct size impact type socket.
- 2) Use extra deep sockets in place of extension bars where possible.
- 3) Do not use oversized, worn or cracked sockets.
- 4) Hold the wrench so the socket fits squarely on the fastener. Hold the wrench firmly, but not too tightly, pressing forward slightly.

Dismantling & Assembly Instructions

Disconnect tool from air supply.

Remove oil plug (34) and position tool so that the oil in the clutch housing can be drained into a suitable container. Grip motor housing (1) in a vise fitted with soft jaws and remove 4 screws with washers (36) from clutch housing (35) with O-ring (33) and oil seal (37). Oil seal (37) may be pressed out of clutch housing (35) if replacement is needed. Remove anvil spacer (30) noting that on reassembly, the chamfered side of spacer goes toward the hammer cage (25). Gripping hammer cage (25), pull out complete twin hammer mechanism. Pull out anvil (29) or (38), noting the orientation of twin hammers (24) for reassembly. Remove thrust button (27) and compression fitting (28). Push out hammer pins (26) from hammer cage (25) allowing twin hammers (24) to be released. Socket retaining ring (32) and O-ring (31) may be pried off anvil (29) or (38) if replacement is needed.

Remove 4 screws (22, 23) from end cap unit (21) noting the longer screws (23) will be returned to the bottom two holes during reassembly. Carefully pry off end cap (21) complete with air regulator and gasket (20). Do not remove air regulator from end cap unit (21). Pull out reverse valve unit (10) from motor housing (1). Remove drive motor assembly and support rod (43) from motor housing (1). Remove guide pin (19) from rear plate (18)

allowing rear plate (18) to be removed from front plate (14). Ball bearing (11) may be removed from rear plate (18). Remove 6 rotor blades (16) from rotor (17). Ball bearing (11), oil seal (12) and O-ring (13) may be removed from front of cylinder (15). Using a suitable punch, tap out spring pin (9) and remove throttle trigger (7). Unscrew hose adaptor (6) and remove exhaust deflector (5), throttle spring (4) and valve stem (3). Do not attempt to remove grip from motor housing (1).

Reassembly

Place front gasket (44) on the motor housing assembly and put O-ring (33) into the groove of the housing. Never place the front gasket upside down. Insert 4 support rods (43) into the corner slots of the motor housing assembly provided for the torx screws.

Clean all parts and examine for damage and wear. Particularly examine O-rings and oil seals for cuts and wear. Also carefully check for cracks and wear on hammer pins (26), twin hammers (24), hammer cage (25) and anvil (29), particularly in the area of the square drive. Replace all parts where necessary with manufacturer supplied parts. Lightly coat all parts with a suitable pneumatic tool lubricating oil and assemble in the reverse order. Apply Locktite 271 to thread on hose adaptor (6) before assembly. On completing assembly, remove oil plug (34) and pour into the front end 5/8 fl. oz. (15cc) of a standard SAE20 grade oil and replace oil plug (34). Pour in approx. 5 ml of a good quality lubricating oil, one preferably containing a rust inhibitor, into the hose adaptor (6) with the trigger (7) depressed. Connect to a suitable air supply and run the tool for a few seconds to allow the oil to circulate. Check the function of the trigger (7), reverse valve (10) and regulator and reset for operation required. Refer to section Operating.

Operation Specification	
Air Consumption	3.9 cfm (28 scfm)
Max. Torque Reverse	600 ft.lbs. (814 Nm)
Max. Torque Forward	550 ft.lbs. (746 Nm)
Working Torque	100-450 ft.lbs. (136-610 Nm)
Air Inlet Thread	1/4-18NPT
Overall Length	7.8" (197 mm)
at 90 PSIG/6.2 bar	

Notes



Declaration of Conformity Sioux Tools Inc.

250 Snap-on Drive, P.O. Box 1596, Murphy, NC 28906, U.S.A.

declare under our sole responsibility that the product

Model IW50HAP-4F / IW50HAP-4P Impact Wrenches, Serial Number

to which this declaration relates is in conformity with the following standard(s) or other normative document(s)

EN792 (Draft), EN292 Parts 1 & 2, ISO 8662 Parts 1 & 7, Pneurop PN8NTC1

following the provisions of **89/392/EEC as amended by 91/368/EEC & 93/44/EEC Directives**

Gerald E. Seebeck
Gerald E. Seebeck (President)

Name and signature or equivalent marking of authorized person