



**Operating Instructions and Parts Manual**  
**50-inch Electrical Slip Roll Machine**  
Model ESR-1650T



**WALTER MEIER (Manufacturing) Inc.**  
427 New Sanford Road  
LaVergne, Tennessee 37086  
Ph.: 800-274-6848  
[www.waltermeier.com](http://www.waltermeier.com)

**Part No. M-756027**  
Revision B 07/2012

Copyright © 2012 Walter Meier (Manufacturing), Inc.

# Warranty and Service

Walter Meier (Manufacturing) Inc., warrants every product it sells. If one of our tools needs service or repair, one of our Authorized Service Centers located throughout the United States can give you quick service. In most cases, any of these Walter Meier Authorized Service Centers can authorize warranty repair, assist you in obtaining parts, or perform routine maintenance and major repair on your JET® tools. For the name of an Authorized Service Center in your area call 1-800-274-6848.

## MORE INFORMATION

Walter Meier is consistently adding new products to the line. For complete, up-to-date product information, check with your local Walter Meier distributor, or visit [waltermeier.com](http://waltermeier.com).

## WARRANTY

JET products carry a limited warranty which varies in duration based upon the product (MW = Metalworking, WW = Woodworking).

<b>90</b> DAY WARRANTY	<b>1</b> YEAR WARRANTY	Body Repair Kits Bottle Jacks Cable Pullers Cold Saws Hoists-Air Hoists-Electric Metal forming Mill/Drills Milling Machines MW Bandsaws MW Drill Presses MW Finishing Equipment MW Lathes MW Precision Vises	<b>2</b> YEAR WARRANTY	Palet Trucks Rigging Equip. Service Jacks Stackers Surface Grinders Tapping Trolleys-Air Trolleys-Electric Web Slings Winches-Electric	<b>3</b> YEAR WARRANTY	WW Benchtop Tools	<b>5</b> YEAR WARRANTY	Beam Clamps Chain Hoist- Manual Lever Hoists Pullers-JCH Models Scissor Lift Tables Screw Jacks Trolleys-Geared Trolleys-Plain Winches-Manual WW Air Filtration WW Bandsaws WW Buffers	WW Drill Presses WW Dust Collectors WW Dust Filters WW Dust Fittings WW Jointers WW Lathes WW Planers WW Sanders WW Shapers WW Tablesaws	<b>LIFE</b> LIFETIME WARRANTY	Fastening Tools Mechanics Hand Tools Striking Tools Vises (no -precision) Clamps
Warranty reverts to 1 Year Warranty if woodworking (WW) products listed above are used for industrial or educational purposes.											

## WHAT IS COVERED?

This warranty covers any defects in workmanship or materials subject to the exceptions stated below. Cutting tools, abrasives and other consumables are excluded from warranty coverage.

## WHO IS COVERED?

This warranty covers only the initial purchaser of the product.

## WHAT IS THE PERIOD OF COVERAGE?

The general JET warranty lasts for the time period specified in the product literature of each product.

## WHAT IS NOT COVERED?

Five Year Warranties do not cover woodworking (WW) products used for commercial, industrial or educational purposes. Woodworking products with Five Year Warranties that are used for commercial, industrial or education purposes revert to a One Year Warranty. This warranty does not cover defects due directly or indirectly to misuse, abuse, negligence or accidents, normal wear-and-tear, improper repair or alterations, or lack of maintenance.

## HOW TO GET SERVICE

The product or part must be returned for examination, postage prepaid, to a location designated by us. For the name of the location nearest you, please call 1-800-274-6848.

You must provide proof of initial purchase date and an explanation of the complaint must accompany the merchandise. If our inspection discloses a defect, we will repair or replace the product, or refund the purchase price, at our option. We will return the repaired product or replacement at our expense unless it is determined by us that there is no defect, or that the defect resulted from causes not within the scope of our warranty in which case we will, at your direction, dispose of or return the product. In the event you choose to have the product returned, you will be responsible for the shipping and handling costs of the return.

## HOW STATE LAW APPLIES

This warranty gives you specific legal rights; you may also have other rights which vary from state to state.

## LIMITATIONS ON THIS WARRANTY

WALTER MEIER (MANUFACTURING) INC., LIMITS ALL IMPLIED WARRANTIES TO THE PERIOD OF THE LIMITED WARRANTY FOR EACH PRODUCT. EXCEPT AS STATED HEREIN, ANY IMPLIED WARRANTIES OR MERCHANTABILITY AND FITNESS ARE EXCLUDED. SOME STATES DO NOT ALLOW LIMITATIONS ON HOW LONG THE IMPLIED WARRANTY LASTS, SO THE ABOVE LIMITATION MAY NOT APPLY TO YOU.

WALTER MEIER SHALL IN NO EVENT BE LIABLE FOR DEATH, INJURIES TO PERSONS OR PROPERTY, OR FOR INCIDENTAL, CONTINGENT, SPECIAL, OR CONSEQUENTIAL DAMAGES ARISING FROM THE USE OF OUR PRODUCTS. SOME STATES DO NOT ALLOW THE EXCLUSION OR LIMITATION OF INCIDENTAL OR CONSEQUENTIAL DAMAGES, SO THE ABOVE LIMITATION OR EXCLUSION MAY NOT APPLY TO YOU.

Walter Meier sells through distributors only. The specifications in Walter Meier catalogs are given as general information and are not binding. Members of Walter Meier reserve the right to effect at any time, without prior notice, those alterations to parts, fittings, and accessory equipment which they may deem necessary for any reason whatsoever. JET®-branded products are not sold in Canada by Walter Meier.

# Table of Contents

Warranty and Service .....	2
Table of Contents .....	3
Warnings .....	4
Introduction .....	5
Specifications .....	6
Features and Terminology .....	7
Unpacking .....	8
Electrical Connection .....	8
Operation .....	8
Roll Adjustment.....	8
Foot Pedal Operation .....	9
Forming the Workpiece.....	9
Material Size Considerations.....	9
Flat Rolling.....	9
Forming a Radius.....	9
Forming a Tube.....	9
Bending Wire .....	10
Maintenance.....	10
Troubleshooting the ESR-1650T Slip Roll .....	10
Replacement Parts .....	11
Assembly Drawing for ESR-1650T .....	11
Parts List for ESR-1650T .....	12
Wiring Diagram for ESR-1650T-1 .....	15
(Single Phase only) .....	15
Wiring Diagram for ESR-1650T-3 .....	16
(Three Phase only).....	16

# Warnings

1. Read and understand the entire owner's manual before attempting assembly or operation.
2. Read and understand the warnings posted on the machine and in this manual. Failure to comply with all of these warnings may cause serious injury.
3. Replace the warning labels if they become obscured or removed.
4. This powered slip roll machine is designed and intended for use by properly trained and experienced personnel only. If you are not familiar with the proper and safe operation of a powered slip roll, do not use until proper training and knowledge have been obtained.
5. Do not use this powered slip roll for other than its intended use. If used for other purposes, Walter Meier (Manufacturing) Inc., disclaims any real or implied warranty and holds itself harmless from any injury that may result from that use.
6. Always wear approved safety glasses/face shields while using this powered slip roll machine. Everyday eyeglasses only have impact resistant lenses; they are not safety glasses.
7. Before operating this powered slip roll machine, remove tie, rings, watches and other jewelry, and roll sleeves up past the elbows. Remove all loose clothing and confine long hair. Non-slip, steel-toed footwear, and anti-skid floor strips are recommended.
8. Wear ear protectors (plugs or muffs) during extended periods of operation.
9. Some dust created by power sanding, sawing, grinding, drilling and other construction activities contain chemicals known to cause cancer, birth defects or other reproductive harm. Some examples of these chemicals are:
  - Lead from lead based paint.
  - Crystalline silica from bricks, cement and other masonry products.
  - Arsenic and chromium from chemically treated lumber.Your risk of exposure varies, depending on how often you do this type of work. To reduce your exposure to these chemicals, work in a well-ventilated area and work with approved safety equipment, such as face or dust masks that are specifically designed to filter out microscopic particles.
10. Do not operate this machine while tired or under the influence of drugs, alcohol or any medication.
11. Make certain the switch is in the **OFF** position before connecting the machine to the power supply.
12. Make certain the machine is properly grounded.
13. The slip roller must be anchored to the floor.
14. Make all machine adjustments or maintenance with the machine unplugged from the power source.
15. Remove adjusting keys and wrenches. Form a habit of checking to see that keys and adjusting wrenches are removed from the machine before turning it on.
16. Keep safety guards in place at all times when the machine is in use. If removed for maintenance purposes, use extreme caution and replace the guards immediately.
17. Check damaged parts. Before further use of the machine, a guard or other part that is damaged should be carefully checked to determine that it will operate properly and perform its intended function. Check for alignment of moving parts, binding of moving parts, breakage of parts, mounting and any other conditions that may affect its operation. A guard or other part that is damaged should be properly repaired or replaced.
18. Provide for adequate space surrounding work area and non-glare, overhead lighting.
19. Keep the floor around the machine clean and free of scrap material, oil and grease.
20. Don't use in dangerous environment. Don't use power tools in damp or wet locations, or expose them to rain. Keep work area well lighted.

# Warnings

21. Keep visitors a safe distance from the work area. **Keep children away.**
22. Make your workshop child proof with padlocks, master switches or by removing starter keys.
23. Give your work undivided attention. Looking around, carrying on a conversation and “horse-play” are careless acts that can result in serious injury.
24. Do not overreach. Failure to maintain proper working position can cause you to fall into the machine or allow clothing to get caught, pulling you into the machine.
25. Use the right tool at the correct speed and feed rate. Do not force a tool or attachment to do a job for which it was not designed. The right tool will do the job better and more safely.
26. Use recommended accessories; improper accessories may be hazardous.
27. Maintain tools with care. Keep the machine clean for the best and safest performance. Follow instructions for lubricating the slip roller.
28. Deburr any sharp metal edges of the workpiece before placing it into the slip roller. Use leather gloves when handling workpieces.
29. Keep hands away from the moving rolls.
30. Turn off the machine before cleaning. Use a brush or compressed air to remove chips or debris — do not use your hands.
31. Do not stand on the machine. Serious injury could occur if the machine tips over.
32. Never leave the machine running unattended. Turn the power off and do not leave the machine until it comes to a complete stop.
33. Remove loose items and unnecessary work pieces from the area before starting the machine.

## **Familiarize yourself with the following safety notices used in this manual:**

**CAUTION** This means that if precautions are not heeded, it may result in minor injury and/or possible machine damage.

**WARNING** This means that if precautions are not heeded, it may result in serious injury or possibly even death.

## **Introduction**

This manual is provided by Walter Meier (Manufacturing) Inc., covering the safe operation and maintenance procedures for the JET ESR-1650T Powered Slip Roller. This manual contains instructions on installation, safety precautions, general operating procedures, maintenance instructions and parts breakdown. This machine has been designed and constructed to provide years of trouble free operation if used in accordance with instructions set forth in this manual. If there are any questions or comments, please contact either your local supplier or Walter Meier. Walter Meier can also be reached at our web site: [www.waltermeier.com](http://www.waltermeier.com).

# Specifications

Model .....	ESR-1650T-1 .....	ESR-1650T-3 .....
Stock Number.....	756027 .....	756028 .....

*Construction:*

Frame .....	cast iron .....	cast iron .....
Rolls .....	steel, ground and polished .....	steel, ground and polished .....

*Capacities:*

Maximum Thickness – Mild Steel .....	16 gauge (1.5mm) .....	16 gauge (1.5mm) .....
Maximum Forming Length.....	50" (1300mm) .....	50" (1300mm) .....
Number of rolls .....	3 .....	3 .....
Diameter of Rolls .....	3" (75mm) .....	3" (75mm) .....
Minimum Forming Radius (in.) .....	2" (51mm) .....	2" (51mm) .....
Wire Grooves (in.).....	1/2" (12.8mm) .....	1/2" (12.8mm) .....
.....	3/8" (9.6mm) .....	3/8" (9.6mm) .....
.....	5/16" (8mm) .....	5/16" (8mm) .....

*Motor and Controls:*

Motor .....	TEFC, Induction .....	TEFC, Induction .....
Horsepower .....	1.5 HP (1.1kW) .....	1HP (0.75kW) .....
Phase .....	1 PH .....	3 PH .....
Cycle .....	60Hz .....	60Hz .....
Voltage .....	115/230V (prewired 230V) .....	230/460V (prewired 230V) .....
Full Load Amps.....	13.78 / 6.89 .....	3.48 / 1.74 .....
Motor RPM .....	1680 .....	1680 .....
Control.....	Foot Pedal with Emergency Stop .....	Foot Pedal with Emergency Stop .....
Gear Reducer Ratio .....	1:80 .....	1:80 .....
Driven Roll Speed (RPM).....	22 .....	22 .....

*Dimensions:*

Shipping .....	71"Lx24"Wx43"H (1800x600x1100mm) .....	71"Lx24"Wx43"H (1800x600x1100mm) .....
Assembled.....	65"Lx20"Wx36"H (1660x500x910mm) .....	65"Lx20"Wx36"H (1660x500x910mm) .....

*Weights:*

Net .....	750 lbs (340 kgs) .....	750 lbs (340 kgs) .....
Shipping .....	877 lbs (398 kgs) .....	877 lbs (398 kgs) .....

The specifications in this manual were current at time of publication, but because of our policy of continuous improvement, Walter Meier reserves the right to effect, at any time and without prior notice, changes or alterations to parts, fittings, and accessory equipment deemed necessary, without incurring obligations.

**⚠WARNING** Read and understand the entire contents of this manual before attempting assembly or operation! Failure to comply may cause serious injury!

# Features and Terminology

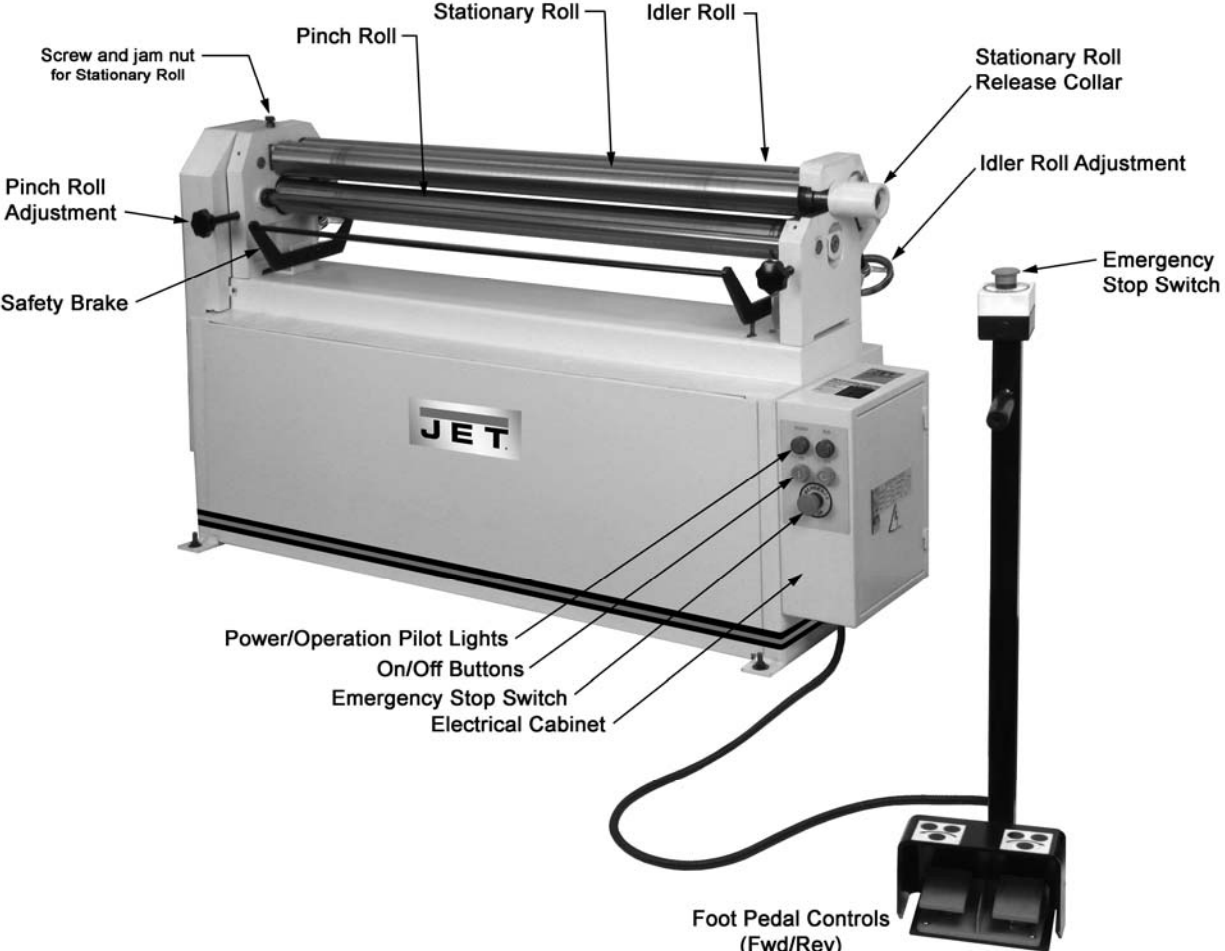

Figure 1 - Features

# Floor mounting holes

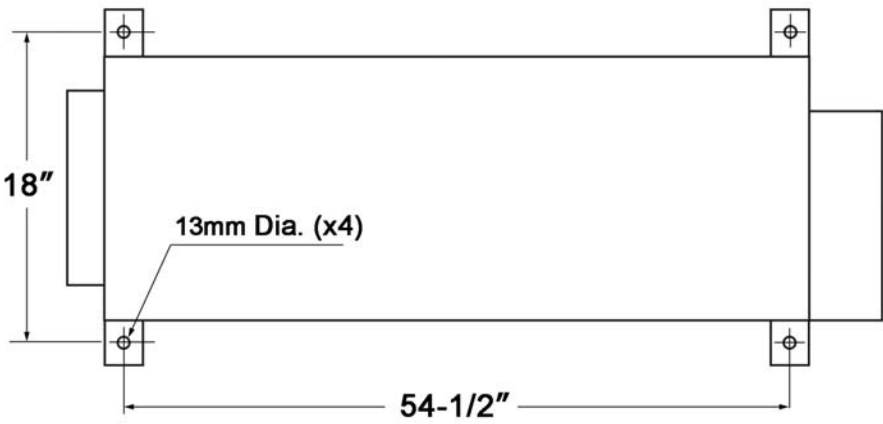

Figure 2 – Hole centers

# Unpacking

Open shipping container and check for shipping damage. Report any damage immediately to your distributor and shipping agent. Do not discard any shipping material until the Slip Roll is assembled and running properly.

Compare the contents of your container with the following parts list to make sure all parts are intact. Missing parts, if any, should be reported to your distributor. Read the instruction manual thoroughly for assembly, maintenance and safety instructions.

## Contents of container:

- 1 Electric Slip Roll
- 1 Foot pedal control assembly
- 2 Keys to electrical box
- 1 Instruction and parts manual
- 1 Warranty card

Remove all crating from around the slip roller, and use a forklift or hoist with straps to carefully move the machine off the pallet and into position. Lifting equipment should be rated for at least 900 pounds.

Position the machine so that there is enough room on all sides for general maintenance and feeding of materials. Anchor the slip roller to the floor using lag screws or other appropriate fasteners through the four holes in the base.

Exposed metal surfaces have been given a protective coating. Remove this with a soft cloth and a cleaner-degreaser. Do not use gasoline, paint thinner, acetone, etc., as these may damage painted surfaces. Do not use an abrasive pad, as it may scratch polished surfaces.

# Electrical Connection

**⚠️WARNING** Electrical power connections should be made by a qualified electrician. Observe national and local electrical codes when connecting this machine.

The ESR-1650T is pre-wired for 230 volt. It is not provided with a power plug; you may either attach a proper 230V UL-listed plug, or "hardwire" the machine directly to a service panel (make sure a disconnect is available to the operator).

The *three-phase* model can be converted to 460 volt, as follows:

- 1. Connect the motor leads according to the diagram affixed to the motor.

- 2. On the transformer, remove the wire terminal from the 230V contact and connect to the 460V contact.
- 3. On the thermal relay, make sure the dial is set to the proper amperage.
- 4. If using a plug, install a proper 460V, UL-listed plug.

It is recommended that the Slip Roll, when operated at either voltage, be connected to a dedicated, minimum 15 amp circuit with a 15 amp circuit breaker or time delay fuse. **Local codes take precedence over recommendations.**

Refer to the *Wiring Diagram* at the back of this manual for more detailed wiring information.

# Operation

## Roll Adjustment

*(Figure 1 identifies machine elements.)*

Four adjustment screws (two in front and two in the rear) have been built into the left and right side frames.

The two front adjusting screws enable the operator to raise or lower the pinch roll, so that the correct gap between the stationary and pinch rolls may be obtained to feed the desired stock into the machine.

The rear adjusting screws raise or lower the idler roll which determines the degree of bend in the stock that is being fed through the machine. The right and left side frames are each equipped with a scale to aid the operator in determining.

To adjust the rolls for material thickness:

- 1. Insert the material between the rolls from the front of the machine and raise the pinch roll until the material fits tightly.
- 2. Raise the idler roll equal amounts at each end, to desired position for the bend.

No exact formula can be followed when making these roll adjustments because material "spring back" varies with the kind of material being formed. Only by test forming several pieces can the correct adjustments be obtained. Also, keep in mind that it is much easier to re-pass material to make a smaller radius than it is to attempt to increase a radius that was made too small.

Rolls must be adjusted exactly parallel or the material will spiral during the rolling process. Measure each end of the opening with calipers if greater precision is required.

NOTE: Deliberately setting the rolls non-parallel can be used to make cone shapes.



The stationary, or top, roll is secured at its left end to the gear side of the machine with the cap screw and jam nut (see Figure 1). These can be adjusted if needed.

## Foot Pedal Operation

The shrouded foot control has pedals for instant forward or reverse motion.

Push the emergency stop button for fast shut down of the slip roller. To re-start the machine, rotate the emergency stop button clockwise until it releases.

## Forming the Workpiece

**⚠WARNING** The rolls present a pinch point and/or crush hazard. Do not place hands in close proximity to the rolls while operating.

### Material Size Considerations

To determine the approximate length of material needed for a desired size tube, use the following formula:

$$C = \pi D$$

where  $C$  is the circumference,  
 $\pi$  equals 3.1417  
 and  $D$  is the diameter.

For example: To find the length of material needed ( $C$ ) to form a tube 4" in diameter, multiply 3.1417 by 4". Result: 12.5667" is the circumference of approximate length of material needed. Cut several pieces of material to this length for a forming test run. Material may have to be lengthened or shortened depending upon results of the test run.

If the workpiece is large, make sure it receives proper support as it exits the slip roll machine.

### Flat Rolling

Softer metals (copper, aluminum, etc.) can be processed through the slip roll machine to straighten, flatten, or reduce their thickness. Simply adjust the pinch roll for thickness, lower the idler roll all the way down, and feed the workpiece through (Figure 2).

NOTE: The idler roll will not descend completely out of the path of the workpiece; thus, there may be a slight bend in the workpiece. By flipping the workpiece over and re-feeding it, this bend can be minimized.

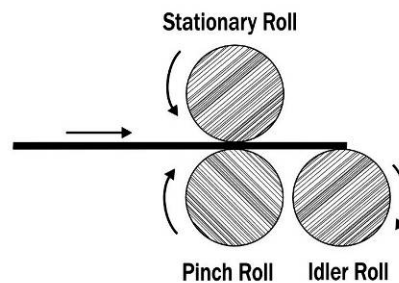

Figure 2

### Forming a Radius

1. Adjust the pinch roll as needed.
2. Turn on the slip roller and insert the workpiece from the front. Make sure the stationary roll is rotating counter-clockwise.
3. When the material reaches the point where the radius is to begin (A, Figure 3), stop the machine and raise the idler roll an equal amount on each end to achieve the desired bend.
4. Re-start the rolls and continue until the bend is completed (B, Figure 3). Support the workpiece as it exits the machine.
5. If a smaller radius is needed, adjust the roll distance and re-feed the workpiece.

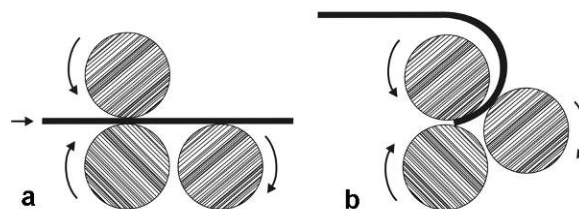

Figure 3

### Forming a Tube

A tube can often be made with a single pass through the machine, as follows:

1. Adjust the pinch roller as needed to accommodate workpiece thickness.
2. Feed the workpiece into the machine. As it nears the end (Figure 4a), stop the machine and reverse direction (Figure 4b).

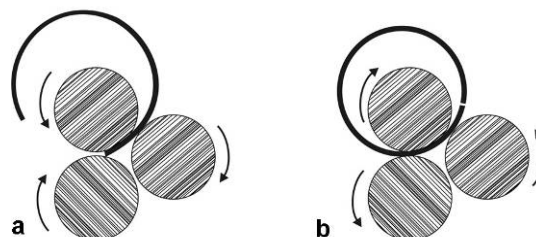

Figure 4

- To remove the tube from the stationary roll, pull the sleeve outward until it clears the end bracket; then pivot the roll outward, as shown in Figure 5.
- After the tube is removed, reposition the stationary roll, making sure the sleeve is pushed back in completely, as shown in Figure 5.

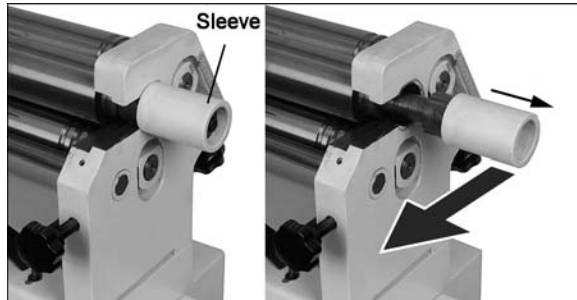

Figure 5

### Bending Wire

There are three wire grooves at the end of the pinch roll and idler roll, to accommodate a 5/16", 3/8" and 1/2" wire. See Figure 6.

Use the smallest groove into which the wire will comfortably fit. Bend the wire using the same principles as described for forming a radius. To make a complete loop of wire, use the instructions for forming a tube.

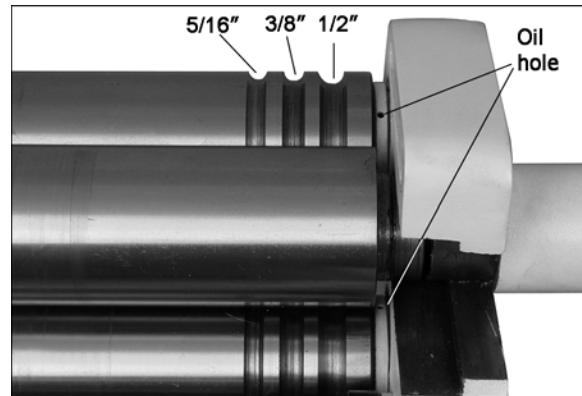

Figure 6

### Maintenance

- Keep the rolls clean and rust-free, and periodically apply a light film of oil.
- Place a few drops of 30W oil into the holes at each end of the rolls (see Figure 6). Then operate the machine for a few seconds to distribute the oil.
- Apply a light coat of oil to the exposed end of the stationary roll beneath the sleeve (shown in Figure 5).
- Keep the gears lubricated with a good quality, non-hardening grease. (Remove end cover to access gears and chain.) Operate the machine to disperse the grease.
- Apply a light coat of grease to the pinch roll and idler roll adjustment screws (see Figure 1).

### Troubleshooting the ESR-1650T Slip Roll

Trouble	Probable Cause	Remedy
Slip roll doesn't operate; rolls won't move.	No incoming power.	Check power source and connections.
	Emergency stop engaged.	Release emergency stop switch by rotating clockwise (check both switch locations).
	Jam nut is loose.	Tighten nut to secure stationary roll.
	Gears damaged.	Inspect gears; repair/replace as needed.
Cones are made when trying to make cylinders.	Rolls not parallel.	Adjust idle (rear) roll as needed until idle roll is parallel to stationary (top) roll.
Workpiece is not bending.	Machine capacity exceeded.	Use materials within machine's capacity.
	Idle Roll not engaging.	Inspect idle roll; make adjustments as needed.

# Replacement Parts

To order parts or reach our service department, call 1-800-274-6848, Monday through Friday (see our website for business hours, [www.waltermeier.com](http://www.waltermeier.com)). Having the Model Number and Serial Number of your machine available when you call will allow us to serve you quickly and accurately.

## Assembly Drawing for ESR-1650T

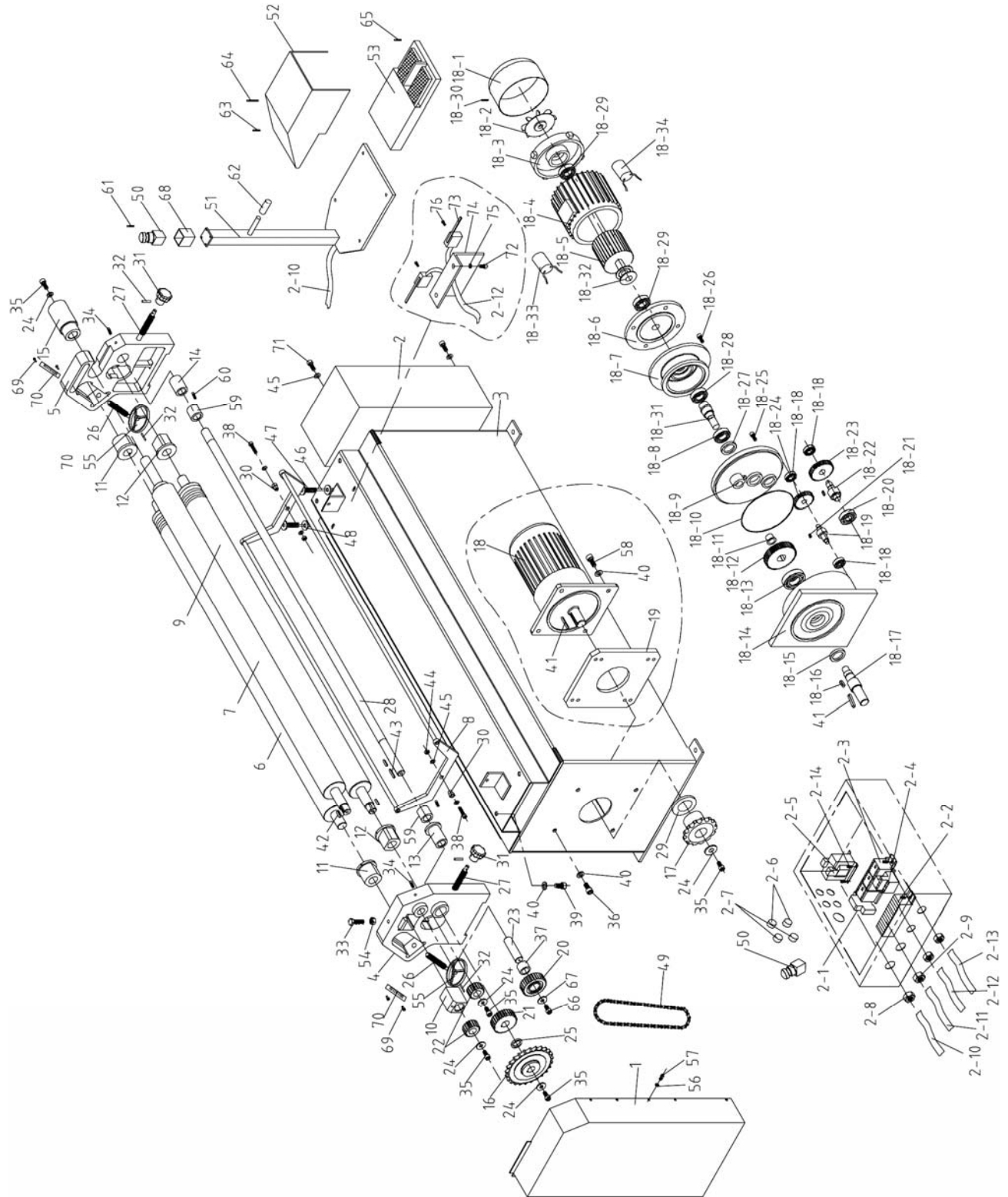

## Parts List for ESR-1650T

Index No	Part No	Description	Size	Qty
1	ESR1650T-1	Side Cover		1
2	ESR1650T-2	Electric Box		1
2-1	ESR1650T-2-1	Short & Overload Protection	Ω1A	1
2-2	ESR1650T-2-2	Junction Terminal		1
2-3	ESR1650T/3-2-3	A.C. Contactor	three phase	3
	ESR1650T/1-2-3	A.C. Contactor	single phase	4
2-4	ESR1650T/3-2-4	Thermal Relay	2.4-3.6A (3PH)	1
	ESR1650T/1-2-4	Thermal Relay	5.5-8.5A (1PH)	1
2-5	ESR1650T/3-2-5	Transformer	AC 460 230/24V	1
	ESR1650T/1-2-5	Transformer	AC 230 115/24V	1
2-6	ESR1650T-2-6	Power Indicator	AC24V	2
2-7	ESR1650T-2-7	Power On/Off Button	25A	2
2-8	ESR1650T-2-8	Strain Relief	M18	3
2-9	ESR1650T/3-2-9	Strain Relief for 230/460V-3PH	M18	1
	ESR1650T/1-2-9	Strain Relief for 115/230V-1PH	M20	1
2-10	ESR1650T-2-10	Cable for Foot Pedal	Ø16 mm	1
2-11	ESR1650T/3-2-11	Motor Cable	4x1.5mm 230/460V-3PH	1
	ESR1650T/1-2-11	Motor Cable	7x1.5mm 115/230V-1PH	1
2-12	ESR1650T-2-12	Cable for Microswitch		1
2-13	ESR1650T/3-2-13	Power Cord for 3 PH	4x1.5mm 230/460V-3PH	1
	ESR1650T/1-2-13	Power Cord for 1 PH	3x1.5mm 115/230V-1PH	1
2-14	TS-1532032	Phillips Pan Head Machine Screw	M4x10	12
3	ESR1650T-3	Stand		1
4	ESR1650T-4	Left Support		1
5	ESR1650T-5	Right Support		1
6	ESR1650T-6	Rear Roll		1
7	ESR1650T-7	Upper Roll		1
8	ESR1650T-8	Safety Bracket		1
9	ESR1650T-9	Lower Roll		1
10	ESR1650T-10	Square Bushing Upper Roll		1
11	ESR1650T-11	Bushing Rear Roll		2
12	ESR1650T-12	Bushing Lower Roll		2
13	ESR1650T-13	Left Bushing Trans Shaft		1
	ESR1650T-13A	Left Bushing Trans Shaft <i>(for serial nos. over 11110037)</i>		1
14	ESR1650T-14	Right Bushing Trans Shaft		1
	ESR1650T-14A	Right Bushing Trans Shaft <i>(for serial nos. over 11110037)</i>		1
15	ESR1650T-15	Sleeve Handle		1
16	ESR1650T-16	Large Sprocket	P=19.05 Z=25	1
17	ESR1650T-17	Small Sprocket	P=19.05 Z=13	1
18	ESR1650T/3-18	Motor, 220/440V-3PH	0.75kW, 4P	1
	ESR1650T/1-18	Motor, 115/230V-1PH	1.1kW, 4P	1
18-1	ESR1650T-18-1	Motor Fan Cover		1
18-2	ESR1650T-18-2	Motor Fan		1
18-3	ESR1650T-18-3	Housing Cover		1
18-4	ESR1650T/3-18-4	Stator	230/460V-3PH	1
	ESR1650T/1-18-4	Stator	115/230V-1PH	1
18-5	ESR1650T/3-18-5	Rotor	230/460V-3PH	1
	ESR1650T/1-18-5	Rotor	115/230V-1PH	1
18-6	ESR1650T-18-6	Flange Plate		1
18-7	ESR1650T-18-7	Flange Plate Input Shaft		1
18-8	BB-6205	Ball Bearing	Φ52XΦ25X15	1
18-9	ESR1650T-18-9	Reducer Cover		1
18-10	ESR1650T-18-10	O-ring	Φ180XΦ2.6 mm	1
18-11	ESR1650T-18-11	Bushing		1
18-12	ESR1650T-18-12	Gear		1
18-13	BB-6207	Ball Bearing	Φ72XΦ35X7 mm	1

Index No	Part No	Description	Size	Qty
18-14	ESR1650T-18-14	Housing		1
18-15	ESR1650T-18-15	Oil Seal	Φ50XΦ35X7 mm	1
18-16	ESR1650T-18-16	Key	8x25 mm	1
18-17	ESR1650T-18-17	Output Shaft		1
18-18	BB-6301	Ball Bearing	Φ37XΦ12X12	3
18-19	ESR1650T-18-19	Gear Shaft		1
18-20	BB-6303	Ball Bearing	Φ52XΦ15X12	1
18-21	ESR1650T-18-21	Key	5X12 mm	1
18-22	ESR1650T-18-22	Gear Shaft		1
18-23	ESR1650T-18-23	Gear		1
18-24	ESR1650T-18-24	Gear		1
18-25	TS-1503061	Socket Head Cap Screw	M6X25	3
18-26	ESR1650T-18-26	Bolt	M5X25	3
18-27	ESR1650T-18-27	Oil Seal	Φ37XΦ17X7	1
18-28	BB-6208	Ball Bearing	Φ80XΦ40X18	1
18-29	BB-6205	Ball Bearing	Φ52XΦ25X12	2
18-30	ESR1650T-18-30	Screw	M4X8	3
18-31	ESR1650T-18-31	Connecting Shaft		1
18-32	ESR1650T/1-18-32	Centrifugal Switch for 1PH only		1
18-33	ESR1650T/1-18-33	Start Capacitor for 1PH only	35uf	1
18-34	ESR1650T/1-18-34	Run Capacitor for 1PH only	200uf	1
19	ESR1650T-19	Motor Mount		1
20	ESR1650T-20	Gear	m=2.5 z=30	1
21	ESR1650T-21	Drive Gear	m=2.5 z=30	1
22	ESR1650T-22	Driven Gear	m=2.5 z=18	2
23	ESR1650T-23	Gear Wheel Shaft		1
24	TS-1550071	Flat Washer	Φ10 mm	6
25	ESR1650T-25	Adjusting Washer	Φ35XΦ25.5X5 mm	1
26	ESR1650T-26	Bolt for Adjusting Roller		2
27	ESR1650T-27	Bolt for Auxiliary Roller		2
28	ESR1650T-28	Transmission Shaft		1
29	ESR1650T-29	Washer		1
30	ESR1650T-30	Bushing		2
31	ESR1650T-31	Handle		4
32	ESR1650T-32	Pin		4
33	ESR1650T-33	Bolt	M12X55	1
34	TS-1524051	Set Screw	M8x20	2
35	TS-1491021	Hex Cap Screw	M10x20	5
36	ESR1650T-36	Bolt	M12x25	4
37	ESR1650T-37	Bushing		1
38	ESR1650T-38	Screw	M8X40	2
39	TS-1492031	Hex Cap Screw	M12X35	4
40	TS-2360121	Flat Washer	Φ12 mm	8
41	ESR1650T-41	Key	8X45 mm	1
42	ESR1650T-42	Key	6X25 mm	3
43	ESR1650T-43	Key	6X40 mm	1
44	TS-2311081	Nut	M8	2
45	TS-1550061	Flat Washer	Φ8 mm	4
46	ESR1650T-46	Worm Rod		2
47	ESR1650T-47	Lock Spring		2
48	ESR1650T-48	Flat Washer		4
49	ESR1650T-49	Chain		1
50	ESR1650T-50	Emergency Switch		1
51	ESR1650T-51	Pole		1
52	ESR1650T-52	Box Cover		1
53	ESR1650T-53	Pedal Switch		1
54	TS-1540081	Nut	M12	1
55	ESR1650T-55	Wheel		2
56	TS-1540041	Flat Washer	Φ6 mm	5

Index No	Part No	Description	Size	Qty
57	TS-2246162	Socket Head Button Screw	M6X16	5
58	TS-1505051	Socket Head Cap Screw	M10x35	4
59	ESR1650T-59	Connecting Bushing		2
60	ESR1650T-60	Fixing Screw	M6x8	2
61	ESR1650T-61	Cross Head Screw	M6x65	4
62	ESR1650T-62	Handle Sleeve		1
63	TS-2285302	Phillips Pan Head Machine Screw	M5x30	2
64	ESR1650T-64	Cross Head Screw	M5x95	2
65	TS-1534052	Phillips Pan Head Machine Screw	M6x16	4
66	TS-1482041	Hex Cap Screw	M6x20	1
67	TS-1540041	Flat Washer	Φ6 mm	1
68	ESR1650T-68	Switch Box		1
69	ESR1650T-69	Rivet for Scale	Φ2×6 mm	4
70	ESR1650T-70	Scale		2
71	TS-1490031	Hex Cap Screw	M8×20	2
72	TS-1482031	Hex Cap Screw	M6×16	2
73	ESR1650T-73	Microswitch		2
74	ESR1650T-74	Microswitch Mount		1
75	ESR1650T-75	Washer	Φ6 mm	2
76	ESR1650T-76	Screw	M4X10	4

# Wiring Diagram for ESR-1650T-1

## (Single Phase only)

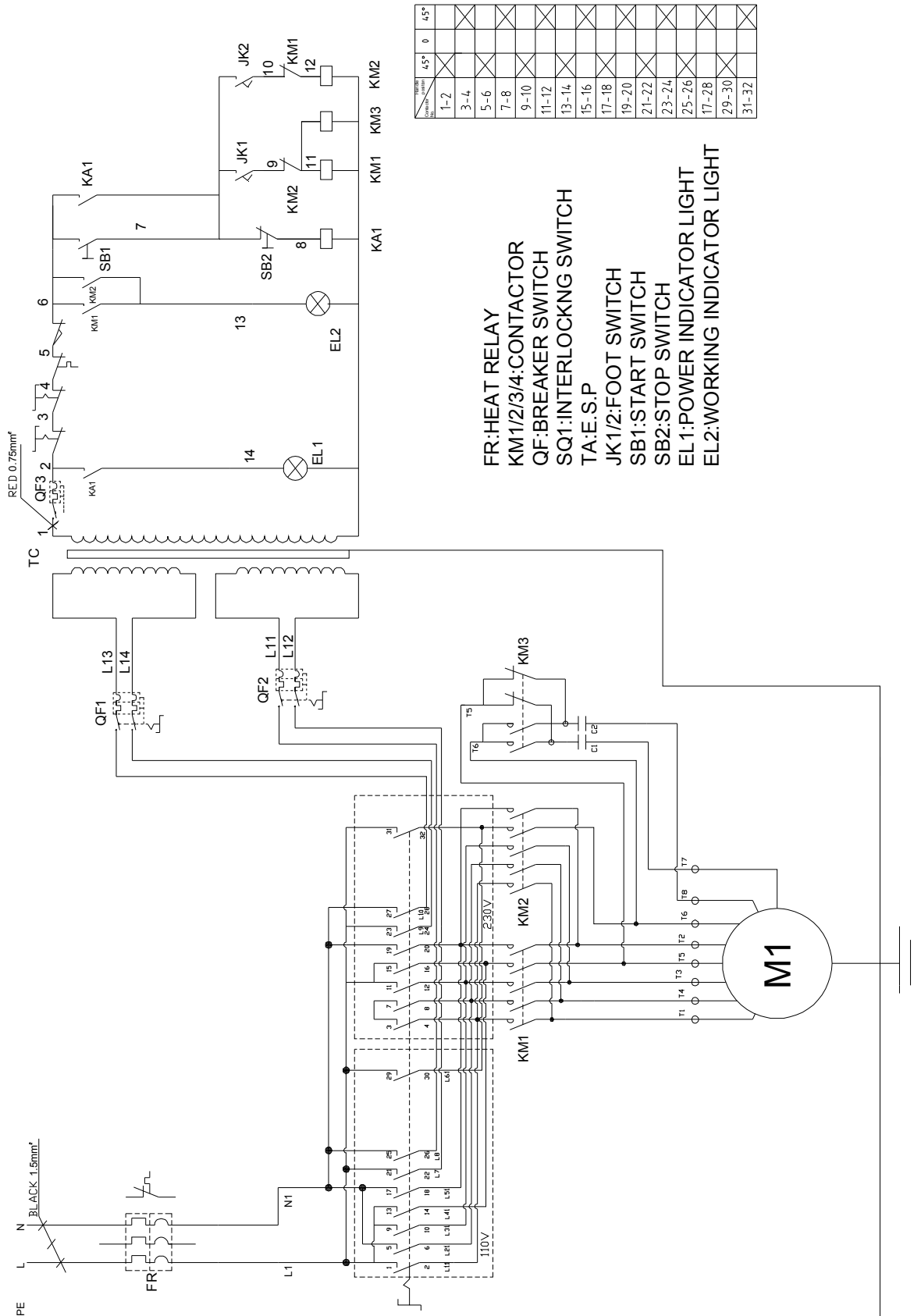

# Wiring Diagram for ESR-1650T-3

## (Three Phase only)

