

F 012 749 201

Stand } 13-12-05 **Fig./Abb. 1**
Issue }

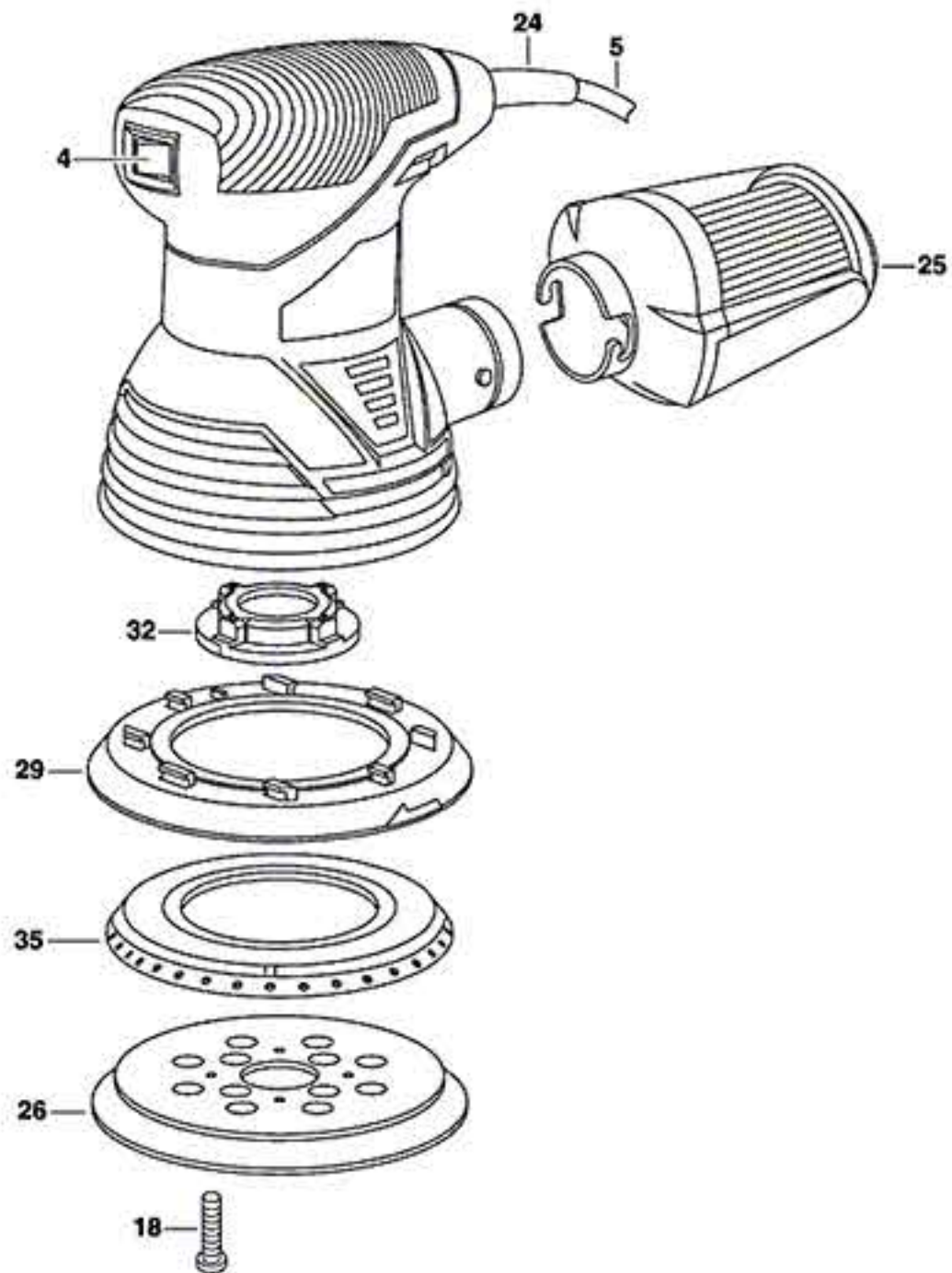

Änderungen vorbehalten
Modifications reserved
Modifications réservées
Salvo modificaciones