

F012 633 500

Issue } 08-11-26
Stand }

Fig./Abb. 1

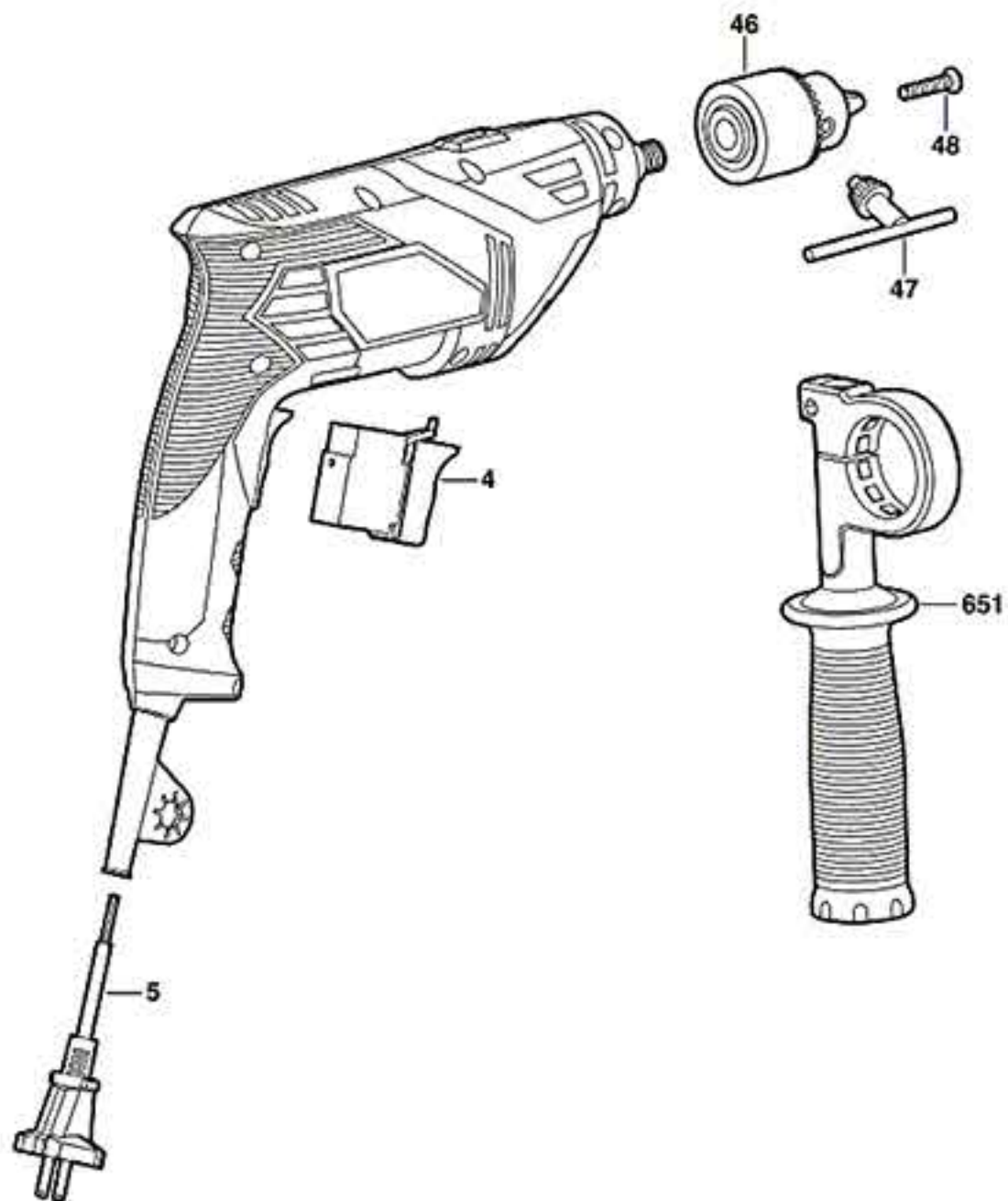

Modifications reserved
Änderungen vorbehalten
Modifications réservées
Salvo modificaciones