

F012 6325 01

Issue } 08-01-14
Stand } **Fig./Abb. 1**

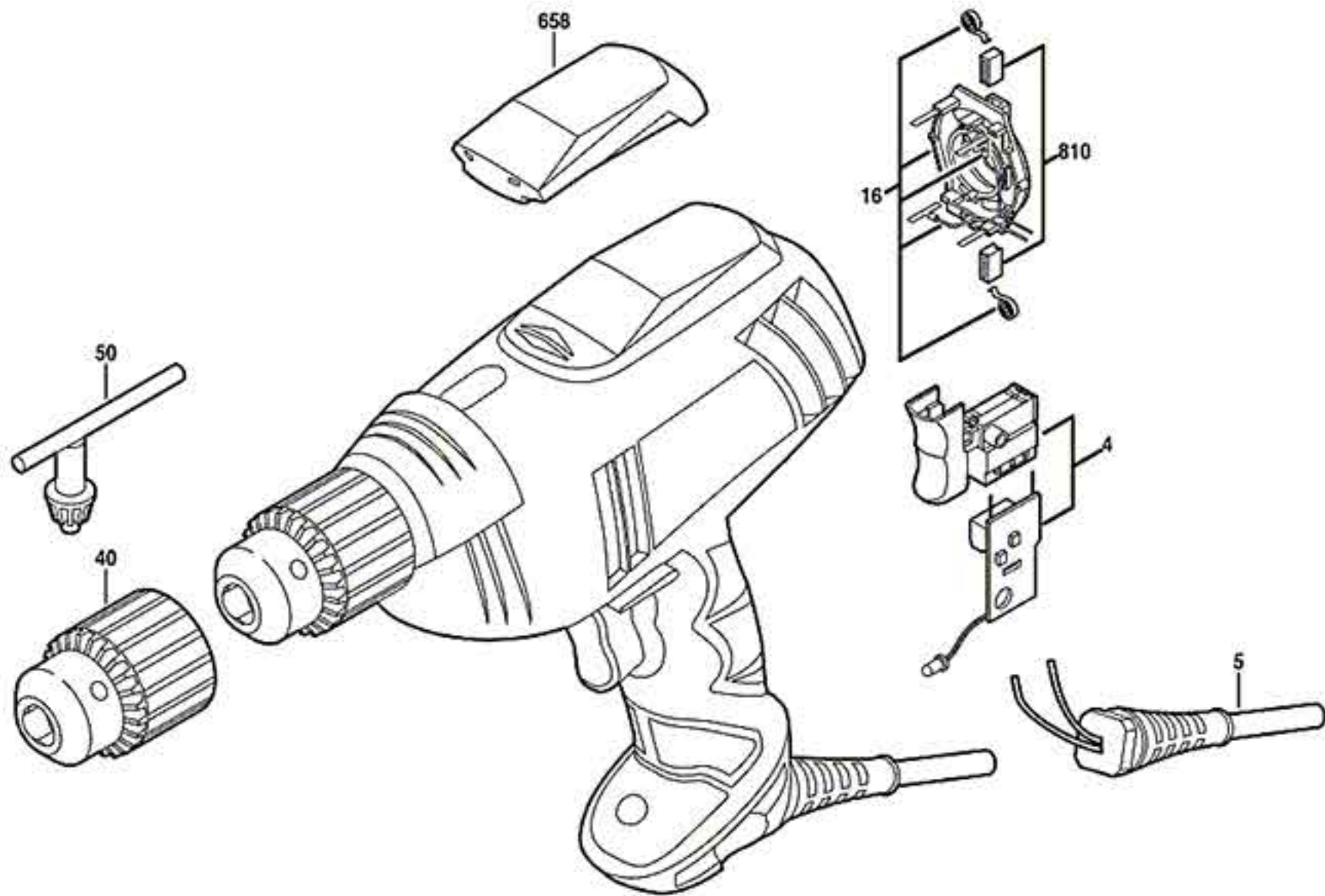

Modifications reserved
Änderungen vorbehalten
Modifications réservées
Salvo modificaciones