

F012 623 500

Issue
Stand 02-08-08

Fig./Abb. 1

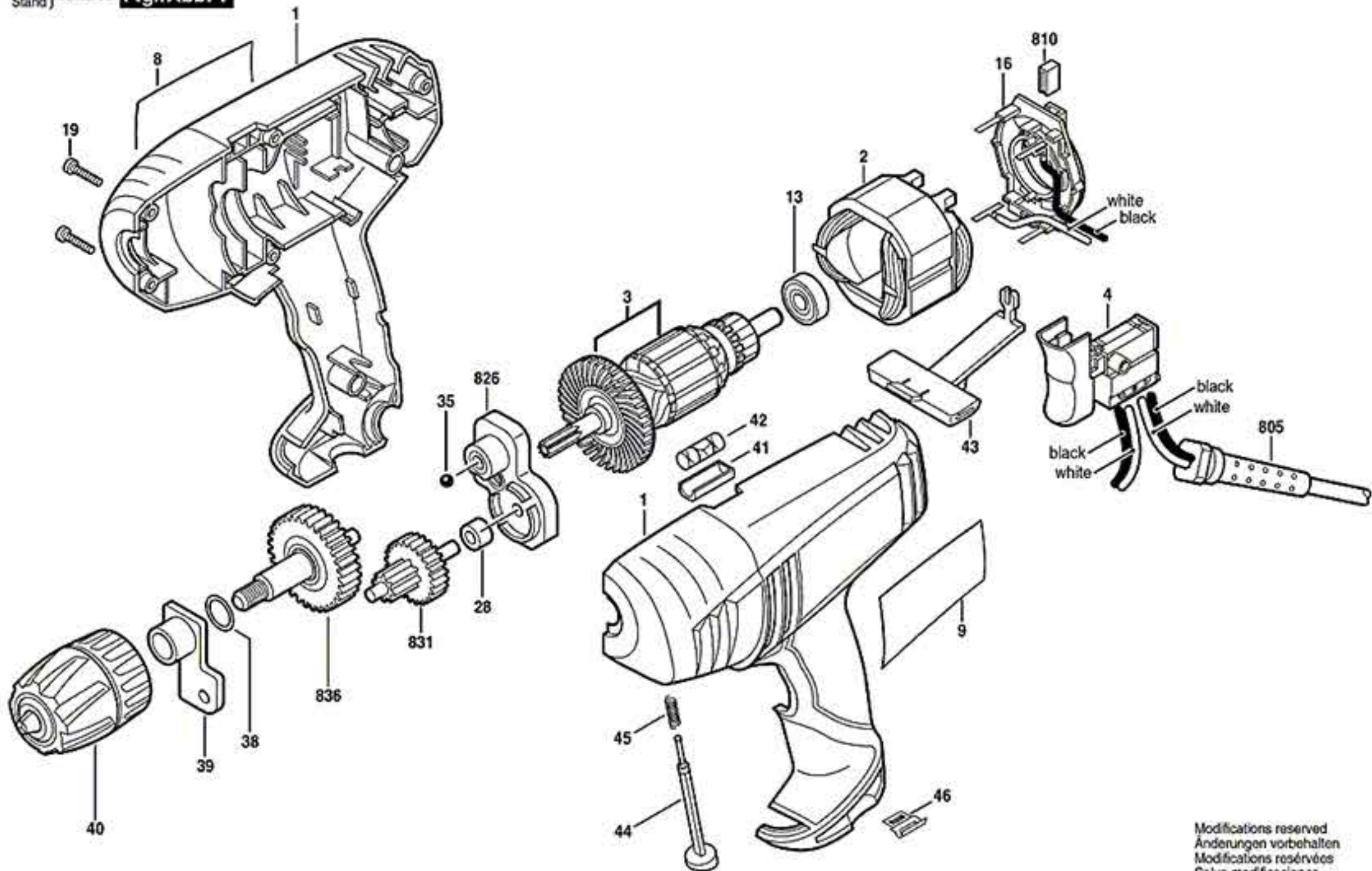

Modifications reserved
Änderungen vorbehalten
Modifications réservées
Salvo modificaciones