

F012 548 001

Issue  
Stand) 10-10-28

**Fig. /Abb. 1**

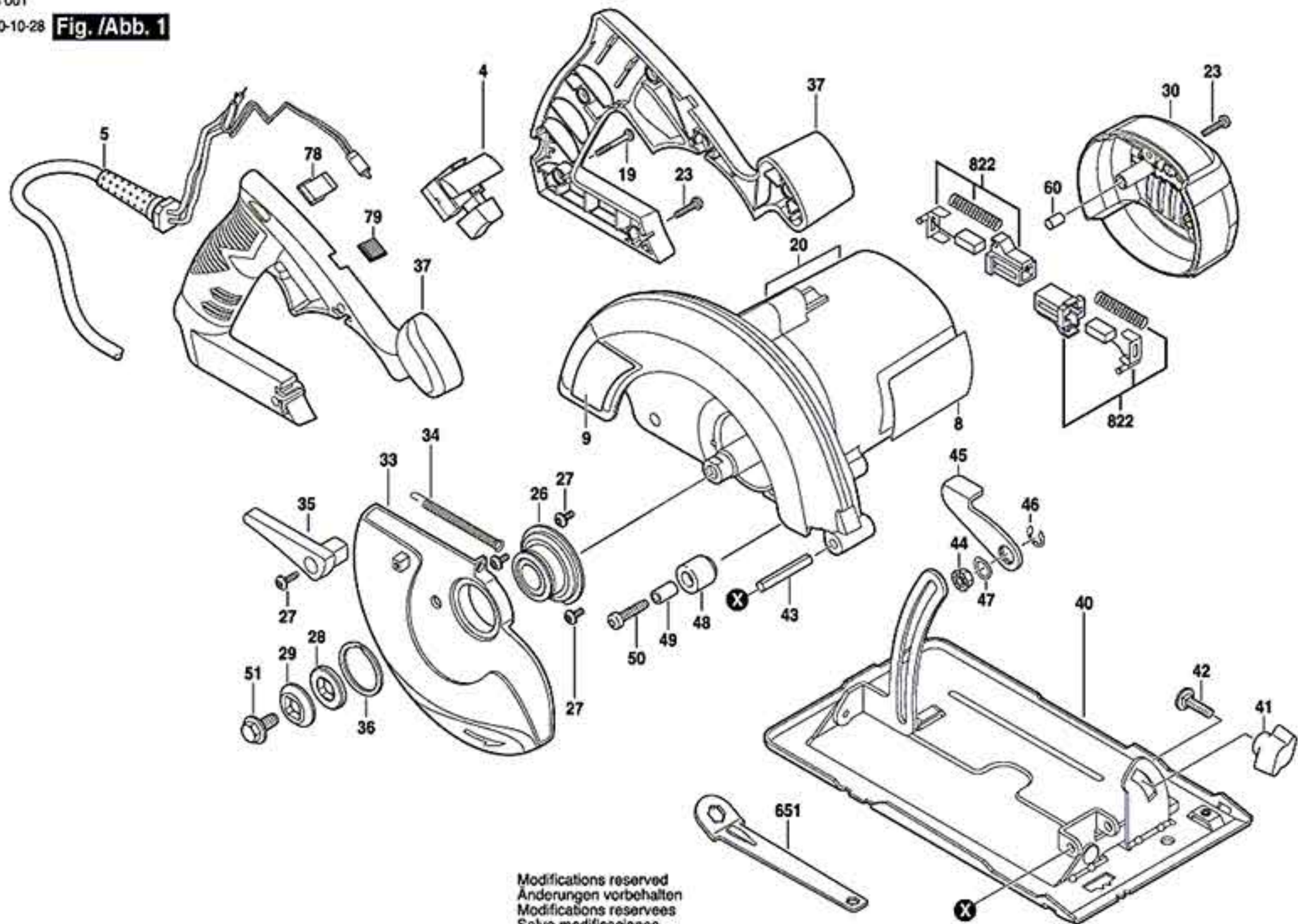

Modifications reserved  
Änderungen vorbehalten  
Modifications reserves  
Salvo modificaciones