

F012 445 500

Issue } 00-09-11
Stand }

Fig./Abb. 1

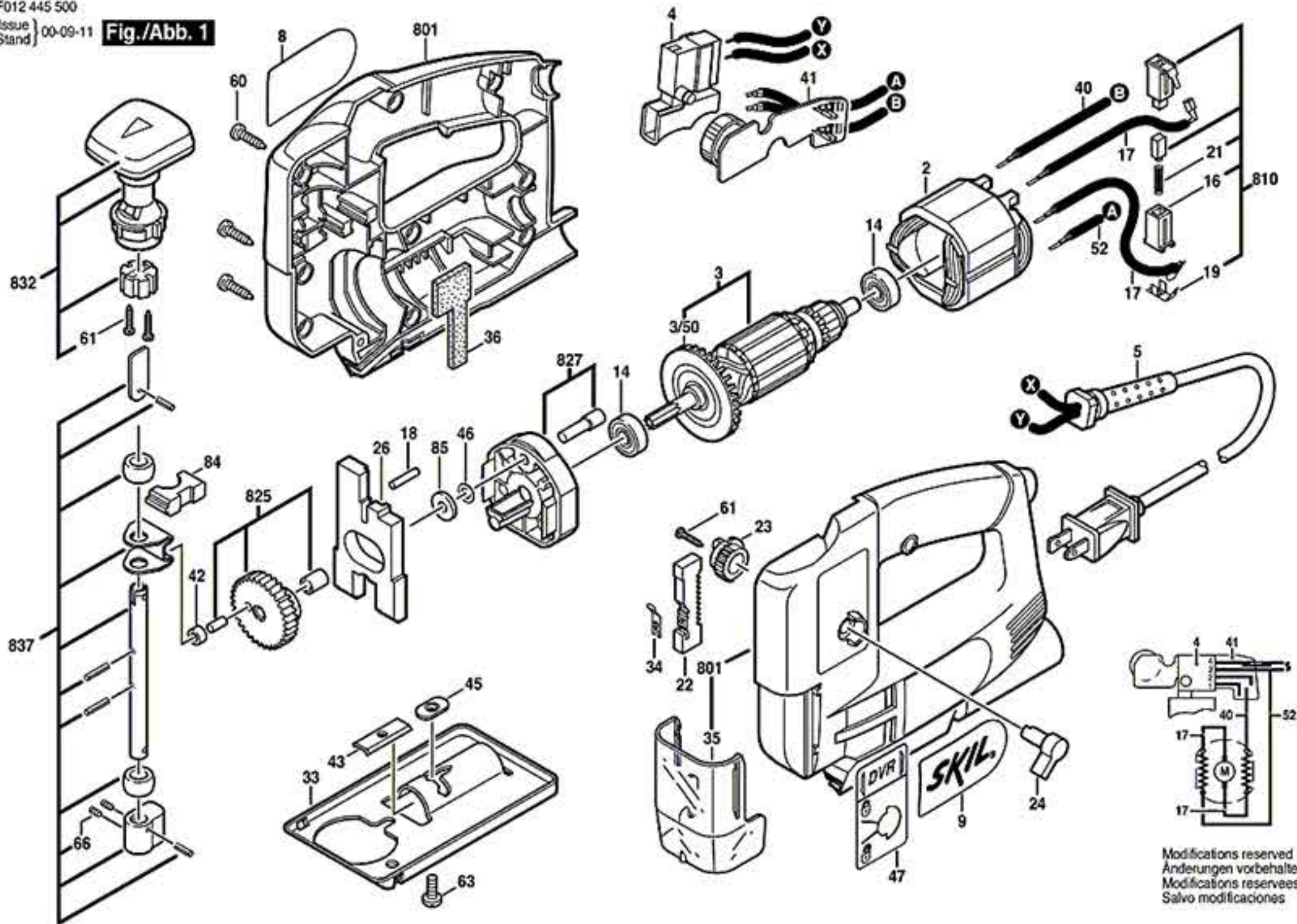

Modifications reserved
Änderungen vorbehalten
Modifications reserves
Salvo modificaciones