

0 601 956 062

Issue } 00-10-30 **Fig./Abb. 1**
Stand }

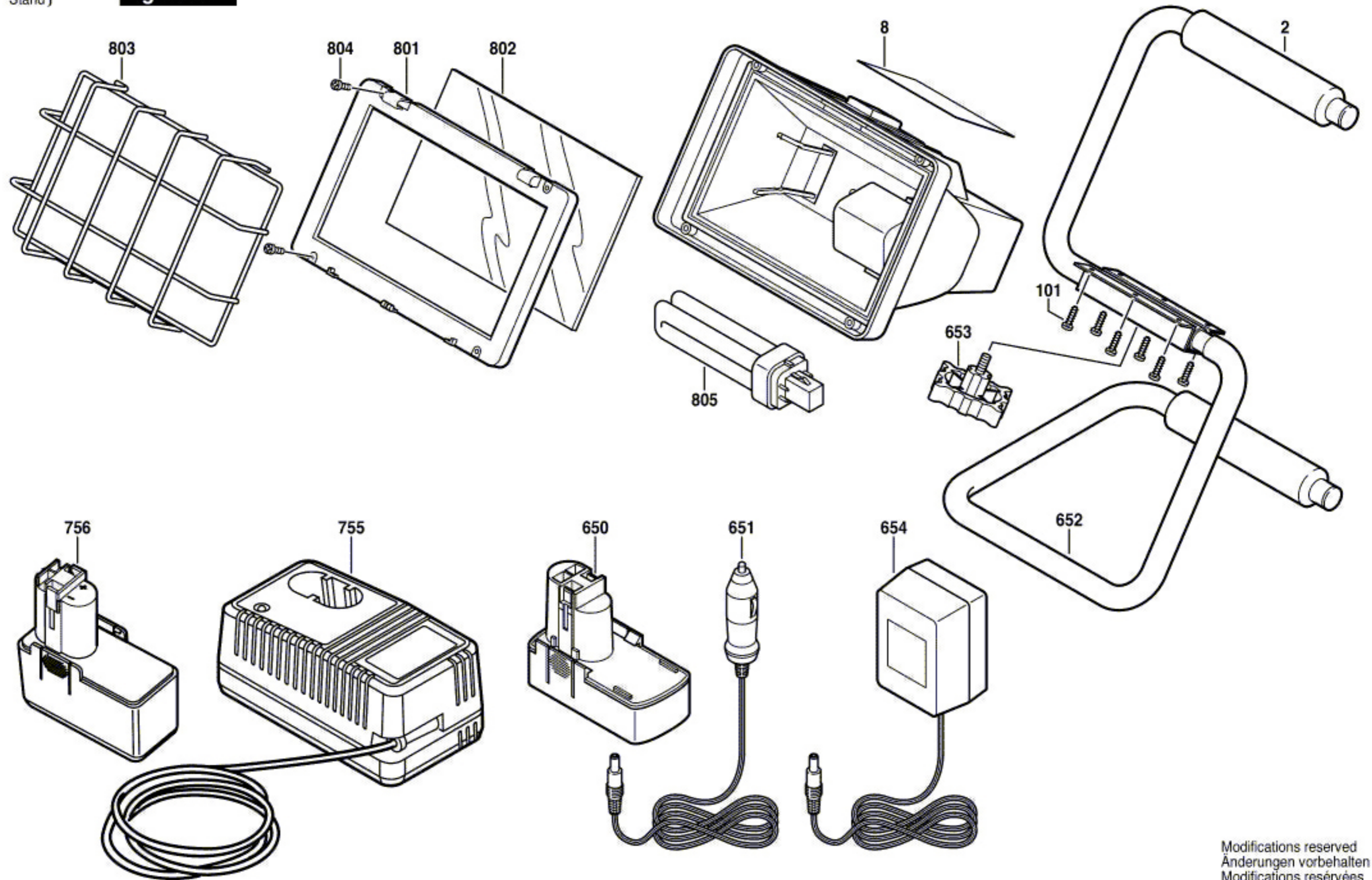

Modifications reserved
Änderungen vorbehalten
Modifications réservées
Salvo modificaciones