

F 012 248 705

Stand } D3-62
Issue } 04-10-06

Fig./Abb. 1

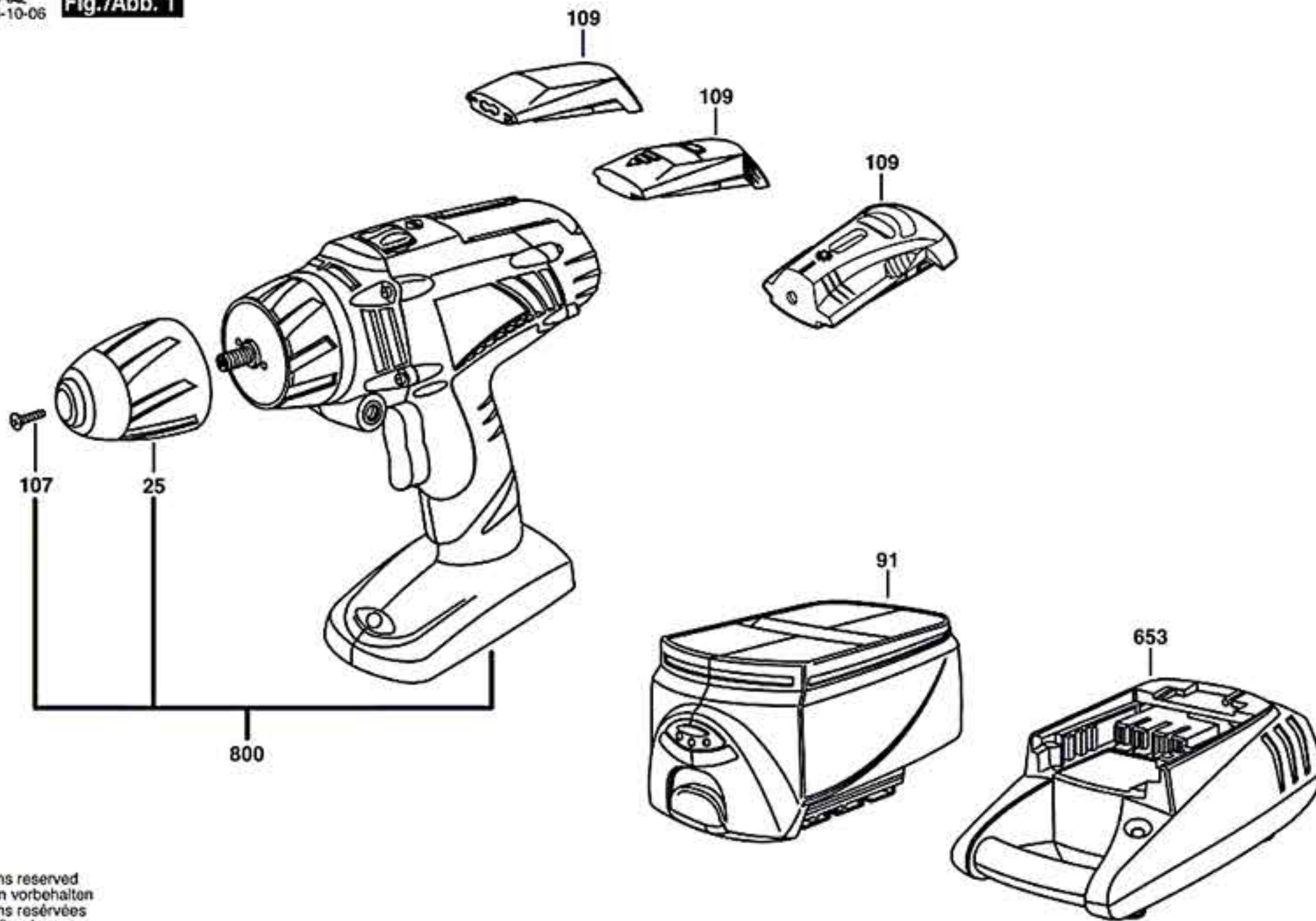

Modifications reserved
Änderungen vorbehalten
Modifications réservées
Salvo modificaciones