

F 012 235 200

Stand } 08-03-20 **Abb./Fig. 1**
Issue }

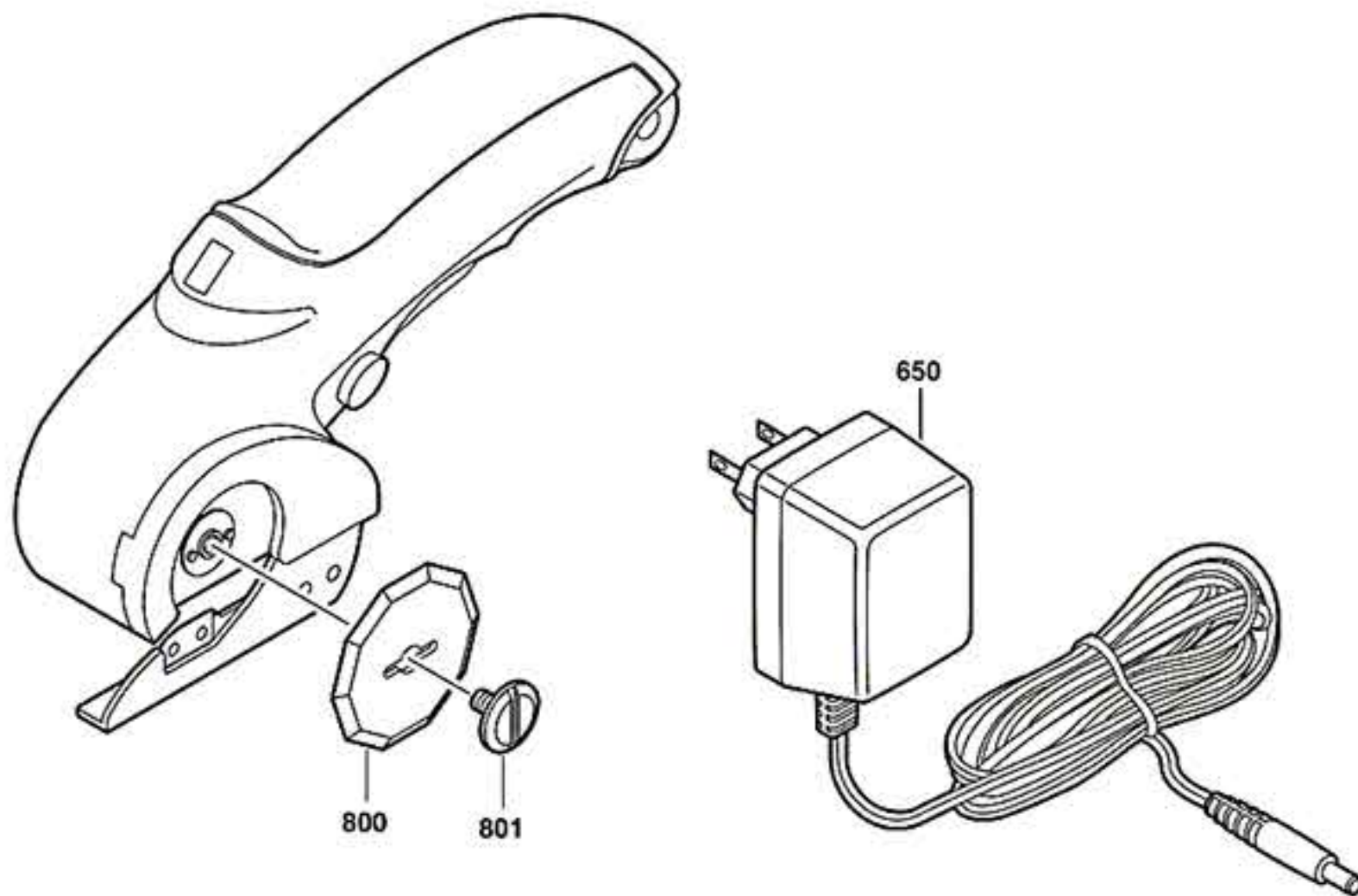

Änderungen vorbehalten
Modifications reserved
Modificaciones reservadas
Salvo modificaciones