

0 601 295 560

Issue } 07-11-08  
Stand }

**Fig./Abb. 1**

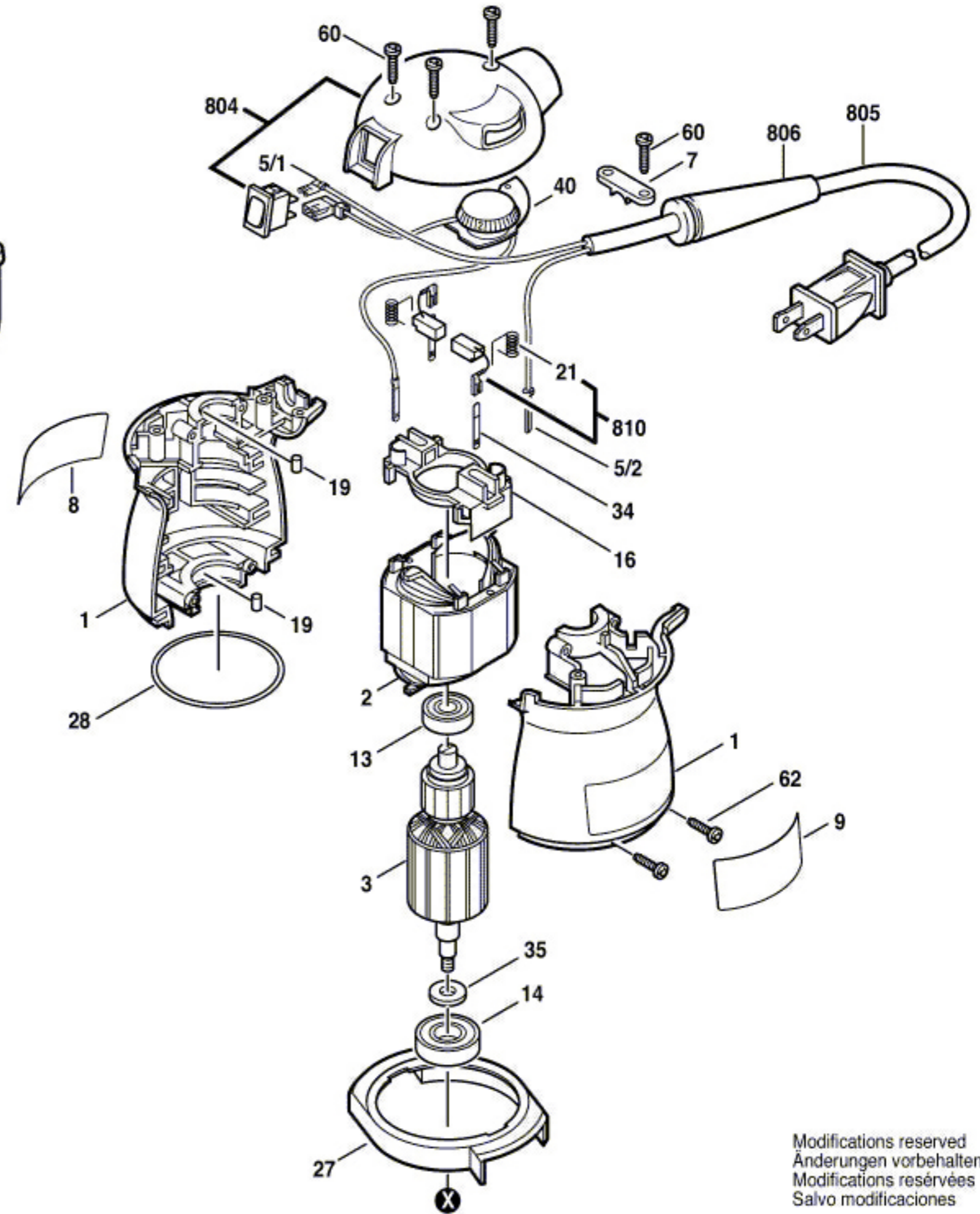
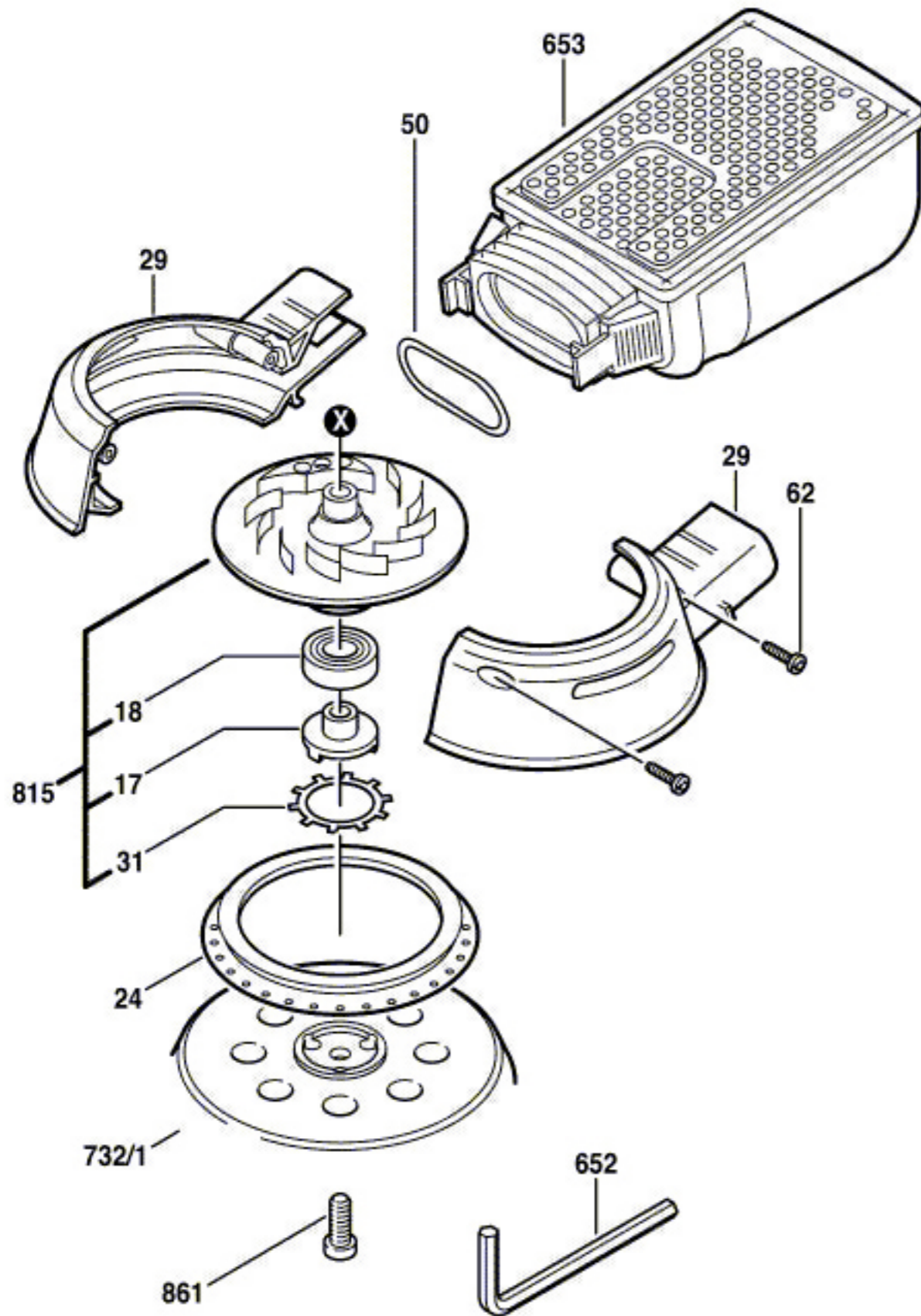

Modifications reserved  
Änderungen vorbehalten  
Modifications réservées  
Salvo modificaciones