

0 601 606 360  
 Issue } 00-07-10  
 Stand }

**Fig./Abb. 1**

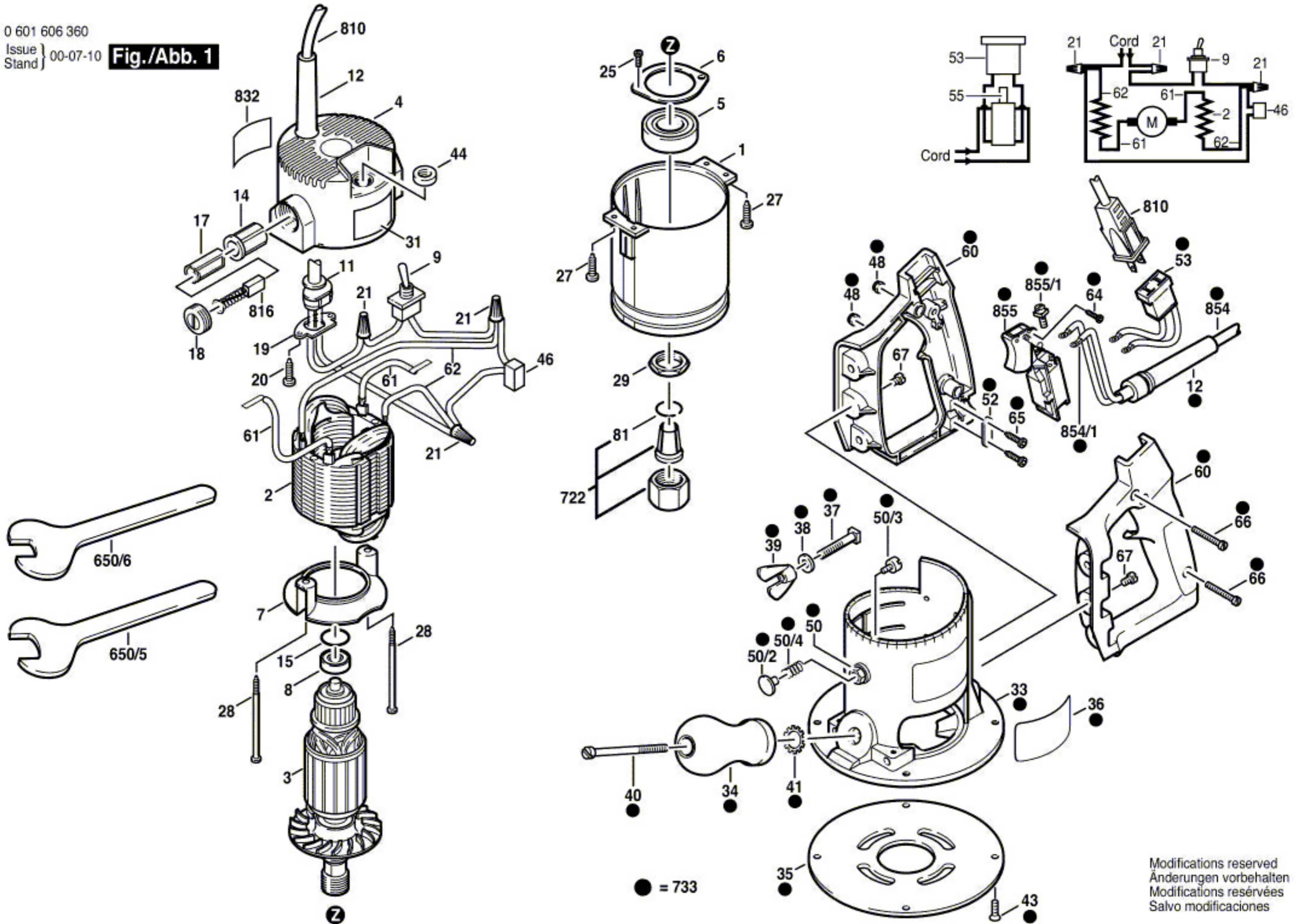

Modifications reserved  
 Änderungen vorbehalten  
 Modifications réservées  
 Salvo modificaciones